



# The Copper Book

for Architecture

 **Aurubis**

The Copper Book  
for Architecture

© 2013 Aurubis  
Second edition 2013  
First edition 2002

We would like to give our special thanks to the The Swedish Sheet Association (Plåtslageriernas Riksförbund, PLR) for allowing us to use photographic and text material from their Swedish book Byggnadsplåt. Likewise we would like to thank: Plåt & Vent Teknikcenter, Lennart Hyse, Joern Adde, Peter Hebeisen, Matti Kallio, Peter Sharpe, Daniel Clements, Nils Petter Dale, Åke E:son Lindman, Esa Kyyrö, Jussi Tiainen, Chris Hodson, Robert Pinter, Graeme Bell, Janne Juhola and all others for the use of their photos.

**Front cover** Skellefteå Kraft. New built headquarter in Skellefteå Sweden. Photo: Åke E:son Lindman  
**Back cover** Svalbard Science Centre. Photo: Nils Petter Dale

ISBN 978-91-637-3300-0

Price 50 €

# The Copper Book for Architecture

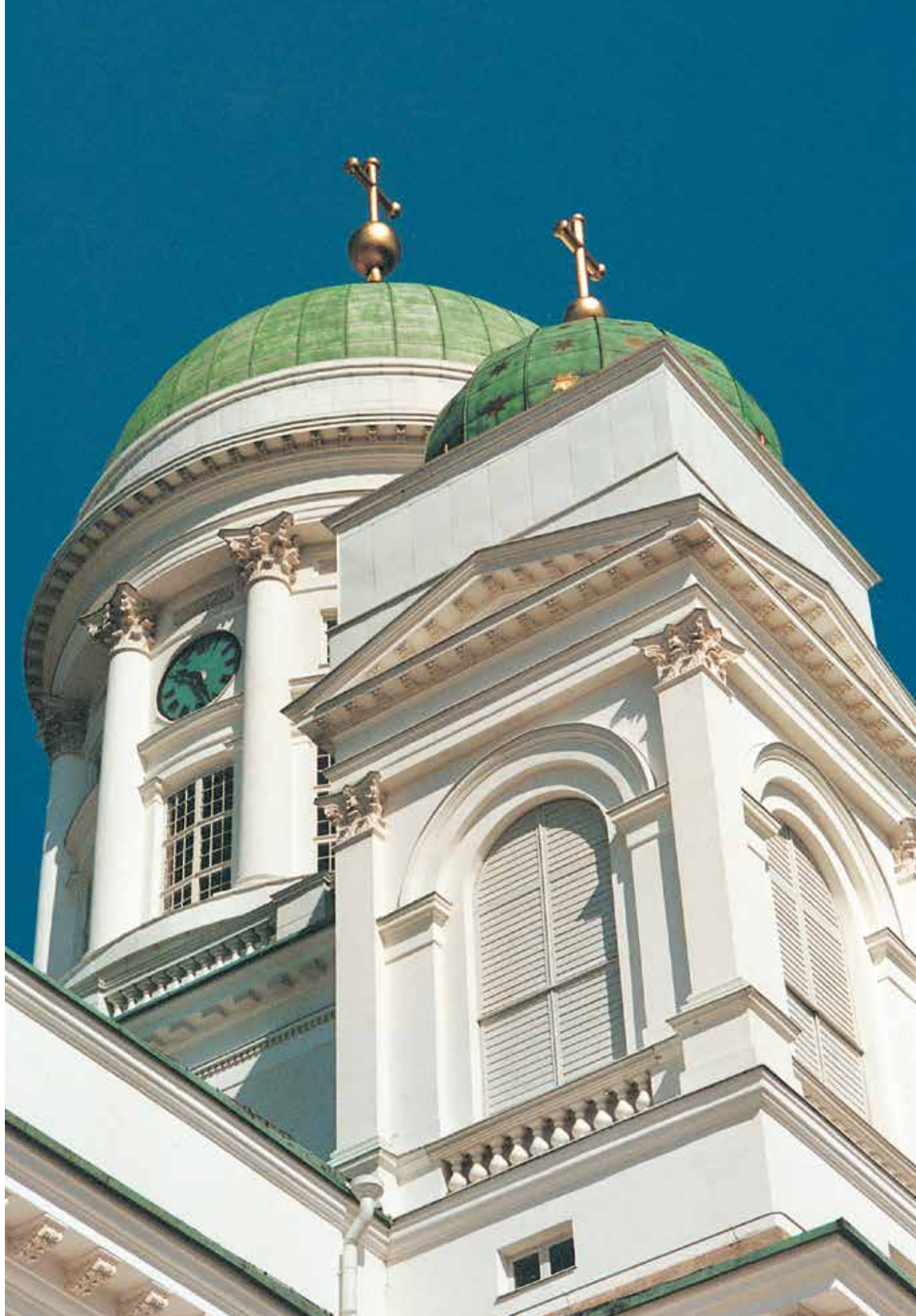

Helsinki Cathedral, Finland

This book, THE COPPER BOOK for Architecture – second edition, is produced by Aurubis and can be described as both a reference book and a source of inspiration, to be used in just the way the reader fancies. To leaf through the pages seeking general knowledge or ideas is as good a reason to open the book as searching for hard facts and specific information of various kinds.

Copper is a material with many important uses worth presenting. We have chosen to do this from a construction-engineering point of view. We will therefore go deeper into some areas, whereas in others, only scratch the surface. Since we focus on the utilisation of copper sheet products for architectural applications, it is only natural that chapters dealing with installation, drawings, technical descriptions etc. have claimed the larger part of the book.

The purpose of this “copper-book” is to give people at both ends of the product flow a common point of reference – to be a forum for dialogue between producer and user, seller and buyer. Between these covers you will find a lot of product information and facts of practical use for all who utilise architectural copper.

It is our hope that architects, designers, project managers and purchasers will embrace this book and make use of it in their work. Reaching for it in the bookcase to find a piece of information or using it for educational purposes.

The important thing is not how, or by whom, it is used but that it will give the reader both knowledge and inspiration. It should inspire confidence when read, and encourage new perspectives in the use of architectural copper.

THE COPPER BOOK for Architecture, is distributed in many countries. You may find specifications and standards that are not relevant to your area. If in doubt, or in case very precise data is required, we recommend our readers to contact the local building construction authorities, Chamber of Commerce or similar.

The book will be revised and extended with every new edition, so we welcome ideas and suggestions that can improve it.

You can find more specific information and facts about Aurubis in the end of this book.

Welcome to THE COPPER BOOK for Architecture,  
– the second edition.

Lennart Engström  
The Editor







Unibank Copenhagen, Denmark  
Nordic Brown Copper Facades





# Contents

<b>AN INTRODUCTION</b>	<b>A historical overview of the sources</b>			<b>TECHNOLOGY</b>	<b>The climatic shell of the building</b>	
<b>TO COPPER</b>	<b>and use of copper</b>	<b>13</b>			External effects	<b>70</b>
	Copper (Cu)	<b>17</b>			Internal exposure	<b>77</b>
	Occurence	<b>18</b>			Movement and movement joints	<b>81</b>
	Mining and ore processing	<b>18</b>			<b>Attachments</b>	
	Supply and demand	<b>19</b>			Attachments and wind loads	<b>92</b>
	Environmental considerations	<b>20</b>			<b>The design of the roof</b>	
	A biological and medical perspective	<b>20</b>			The slope of the roof	<b>96</b>
					Roofing plan	<b>98</b>
<b>PROCESSING</b>	From copper ore to copper sheet	<b>22</b>			Design solutions	<b>100</b>
	Recycled copper	<b>25</b>			Roof safety	<b>102</b>
					<b>Roof covering principles</b>	<b>104</b>
<b>PROPERTIES</b>	Pure copper and copper alloys	<b>26</b>			<b>Substrates roof</b>	<b>106</b>
	Material properties	<b>31</b>			Support at details	<b>108</b>
	Antimicrobial properties of copper	<b>38</b>			<b>The design of the facade</b>	<b>110</b>
<b>NORDIC COPPER</b>	Aurubis Copper Architecture	<b>40</b>			<b>Roof drainage</b>	<b>116</b>
	Nordic Standard mill finish copper	<b>46</b>			<b>Individual details</b>	<b>120</b>
	Nordic Brown pre-oxidised copper	<b>48</b>			<b>SHEET METAL</b>	
	Nordic Green pre-patinated copper	<b>50</b>			<b>Working and forming</b>	<b>130</b>
	Nordic Blue pre-patinated copper	<b>52</b>			<b>Seaming, jointing</b>	<b>138</b>
	Nordic Royal copper alloy	<b>54</b>			<b>Surface treatment</b>	<b>150</b>
	Nordic Brass copper alloy	<b>56</b>			<b>Good house-keeping</b>	<b>160</b>
	Nordic Bronze copper alloy	<b>57</b>			<b>COSTS</b>	
	Nordic forms	<b>58</b>			<b>Cost calculations</b>	<b>168</b>
	Nordic Decor textured surface	<b>60</b>			<b>AURUBIS</b>	
	Profiled sheets	<b>60</b>			<b>Aurubis Copper</b>	<b>172</b>
	Perforated, expanded and woven mesh	<b>61</b>			Aurubis sites worldwide	<b>178</b>
	Transparency with copper	<b>62</b>				
	Pressed surfaces	<b>62</b>				
	Nordic Systems	<b>63</b>				
	Traditional techniques	<b>63</b>				
	Prefabricated systems	<b>64</b>				
<b>STANDARDS</b>	Environmental, quality and					
<b>DIMENSIONS</b>	safety management system	<b>66</b>				
	Properties and tolerances	<b>69</b>				



Statue of Liberty, USA

# An Introduction to Copper



Scientists have reason to believe that the roof of Parthenon Temple Acropolis, Greek (448–432 BC) was made of small copper sheets.

## A historical overview of the sources and uses of copper

Alongside gold, silver and lead, copper was one of the first metals to be worked and formed by human hands. The oldest copper artefacts, primarily decorative objects, were hammered out from surface deposits of pure copper much in the same way as ancient gold objects.

Man's knowledge and use of copper goes far back in time. It is believed that it started about 10,000 years ago. Fragments of copper beads and pins fashioned by working particles of free copper have been found in places in the Middle East (Ali Koch in Iran) and in the region today known as Turkey (Cayönü and Catal Hüyük).

The art of smelting copper carbonate and copper oxide ores was probably developed 2,000–4,000 years later, in the regions of Turkey and a small area between

present-day Israel and Egypt. The production of copper objects has then increased simultaneously with the development of better methods of extracting copper, not least the discovery of the technology of smelting sulphide ores which occurred some 4,500 years ago.

From the middle of the sixth millennium B.C. copper was imported to southern Mesopotamia from sources in Persia. Soon thereafter large amounts of copper objects were to be found in Egypt, especially in the north with its major deposits in Sinai and along the Red Sea. Copper artefacts from Nahal Mishmar in Israel are dated to the fourth millennium B.C., giving evidence to a period of considerable craftsmanship in this precise geographical area.

Copper was first mined in Cyprus at about 3 500 B.C. Cyprus would later become the ancient world's finest source of copper, along with the deposits at Río Tinto in Spain.

Evidence of 5 000 year old copper mines have been found in Egypt. Among other things, these old deposits tell us of how early the knowledge of extracting copper from ore really was. At that time the ore was most probably much richer in copper than what is normal today.

Copper was very well suited for the cold forging in those early days, more so than gold and silver. The Egyptians were so skilled in hammering out their copper sword-edges that it was long believed that they possessed an unknown hardening technique which they kept secret from other civilisations.

The oldest finds of copper objects in Europe are from a 6,000 year old burial site at Varna in Bulgaria, where some of the world's oldest known gold objects were found. Archaeological diggings in the Rudna Glavia area in former Yugoslavia reveal that copper was mined here in a large cave prior to 3000 B.C.

Indochina and Wales are other internationally well known centres where mining took place in prehistoric times.

The first alloy believed to have been used by man was arsenic copper about 3200 B.C. Bronze alloys are thought to have appeared around 3000 B.C. People in those days probably found that pure copper, which was excellent for decorative objects, was not ideal for tools. When it was discovered that a harder metal could be obtained by hammering out the copper with small amounts of added arsenic, the production of utensils, tools and weapons increased dramatically.

The total production of copper between 2000–700 B.C. is estimated at 500,000 tons.

During the great days of the Roman empire copper was mined and used in large quantities for the manufacture of utensils, tools, weapons and coins. The most important deposits in those days were in Spain, Cyprus and in Central Europe. The combined copper production during the period 250 BC to 350 AD is estimated at 5 million tons.

Following the decline and fall of Rome a period of temporary stagnation in the production of copper



Bronze-helmet (300 B.C.) from Amfreville, France.

occurred which lasted up to the ninth century when copper once again came to be extracted in large volumes, particularly in Germany. Significant quantities of copper were mined in China, during the Northern Sung Dynasty (AD 900–1100).

Large-scale industrial production of copper began in the middle of the 19<sup>th</sup> Century with the use of copper in telegraph wires. In 1837 the first telegraph line was laid along the railway line between Euston and Chalk Farm north of London. This first application was soon to be followed by others, among them telegraph cable under the English Channel in 1850. At the end of the Century electric lighting and the use of electricity in industry had become common in the western world.

Today copper and copper alloys are used where properties like high conductivity and good corrosion resistance, colour, formability, tensile strength and ease of joining by soldering is of importance. Basically all electrical wiring in houses are of copper as well as conductor bars in generators and electrical motors. In telecommunications copper is still the predominant conductor material although fibre optic cables are being used more and more.

A major field of application for copper is tubes for tap water and home heating systems. Copper has many advantages compared to competing materials such as plastic and stainless steel. Many of the most common bacteria and virus do not like copper – a fact that ultimately improves water quality and tubes.

Plate, sheet and strip of phosphorus-deoxidised copper is widely used in the building industry. Roofing, panelling, drainpipes and architectural ornamentations have long been the areas of use for this type of copper.



Linköping Cathedral, Sweden.

The production of coins is an old use of copper and copper alloys still common today. The production of copper coins, badges, tokens and medals worldwide use thousands of tons of copper every year.

In view of its acclaimed ability to resist corrosion, copper is now being considered as material to provide containment of spent nuclear fuel. Deep down in underground depositories the character of copper is such that it remains thermodynamically stable and is not oxidised by water soluble substances.

Lesser amounts of copper are used for the production of copper compounds, mainly copper sulphate. Copper compounds have an extensive range of uses; as fungicides and insecticides, additives in animal feed, chemical fertilisers and as a catalyst in chemical processes.

Copper compounds are frequently used for colouring in the glass-, stoneware-, porcelain- and textile industries. Solutions of cuprous chloride are used for the absorption of carbon monoxide and alkanes in industrial gases.

Some of the most important properties that have led to the wide use of copper, and that form the basis for its importance in society today are:

- » It is an excellent electrical conductor, second only to that of silver. In 1913 copper was made a standard for 100 % conductivity, "International Annealed Copper Standard" (IACS).
- » Ductile – can be rolled into foil with a thickness of as little as 7  $\mu\text{m}$ .
- » Good casting properties that facilitates the production of fine details.
- » Easy to join by solder or welding.
- » Resistant to most types of corrosion.
- » Ability to form alloys that – like the pure metal – have attractive colour and can be given a high polish. In many copper alloys, there is very practical balance between tensile strength and conductivity in copper alloys.

# Copper (Cu)

## A METALLIC ELEMENT

Copper occurs both as pure metal and metallic compounds in the earth's crust. In pure form the metal is brownish-red, fairly soft, malleable and very ductile.

Copper belongs to the same group of elements in the periodic table as the noble metals silver and gold.

Copper ranks as the 28<sup>th</sup> most abundant among the elements in the earth's crust with an average concentration of 50–70 mg per kg. The highest concentrations are found in volcanic and basic rock, whereas the lowest are found in lime and sandstone.

Copper is oxidised by air particularly in the presence of moisture and at elevated temperatures. Copper is also oxidised in oxygenated water.

In nature copper mainly occurs with the oxidation numbers +1 and +2 (cuprous with the valence of 1 and cupric in which copper has a valence of 2). Copper interacts readily with many different bio-molecules, and is an essential trace element in all living organisms.

## THE ELEMENTS ARE NATURE'S BUILDING BLOCKS

More than 75 % of our elements are metals. Most of them are heavy metals, i.e. they weigh more than titanium (4.5 g/cm<sup>3</sup>). The expression "heavy metal" does not in itself mean it is harmful. The harmfulness lies in the chemical state, type of compound, quantity etc., and this applies equally to light- and heavy metals. Copper, alongside iron and zinc, is one of the indispensable constituents in all living organisms (so called trace elements).

## COPPER IS A SMALL PIECE OF NATURE

Copper is an integrated part of our environment, both in pure form and as mineral ore. Iron, copper and sulphur play a key role in a new theory on the dawn of life on earth. Copper has been a constituent in all living organisms throughout the evolution of our planet.

Metals and minerals are difficult to dissolve in water. Plants, animals and humans can assimilate electrically charged atoms, so called ions. This is called bio-accessibility. Ionised copper reacts quickly with various materials and is bound into an inaccessible form. Only a minor part of the copper analysed in water, soil or sediment is in an accessible form.

Nature regulates the absorption and discharge of copper in an almost perfect way. Copper is not (bio) accumulated in the body or biological chain.

**Copper** (LL cu'prum, L cy'prum from Cy'prum i.e. Cyprian metal, Gr. Ky'prum whence Ky'pros Cyprus) metallic element, one of the earliest metals used by man, belongs to the group of noble metals in group 1b of the periodic system together with silver and gold, at no. 29, symbol Cu.

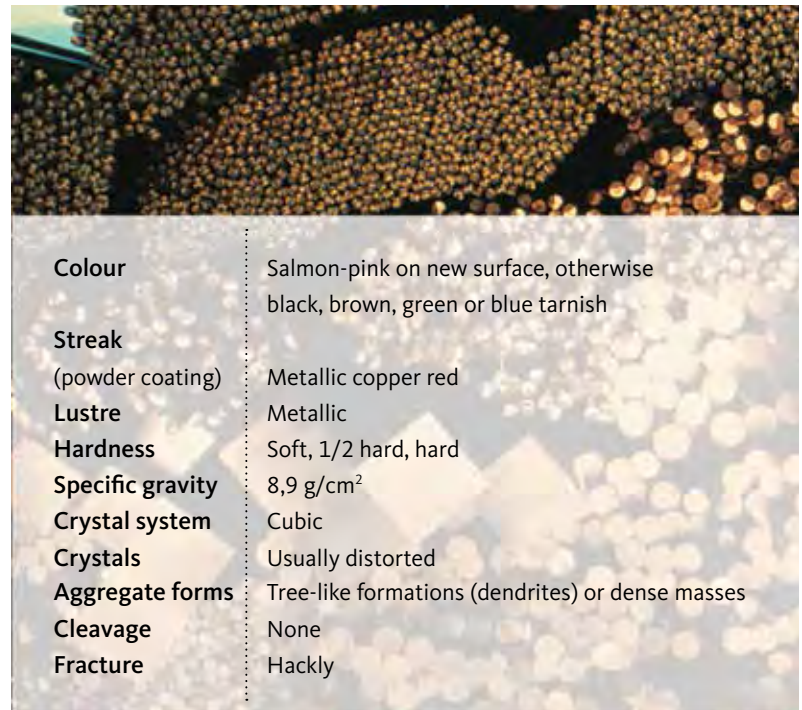

<b>Colour</b>	Salmon-pink on new surface, otherwise black, brown, green or blue tarnish
<b>Streak</b> (powder coating)	Metallic copper red
<b>Lustre</b>	Metallic
<b>Hardness</b>	Soft, 1/2 hard, hard
<b>Specific gravity</b>	8,9 g/cm <sup>3</sup>
<b>Crystal system</b>	Cubic
<b>Crystals</b>	Usually distorted
<b>Aggregate forms</b>	Tree-like formations (dendrites) or dense masses
<b>Cleavage</b>	None
<b>Fracture</b>	Hackly



## Occurrence

The main ore minerals of copper are chalcocite  $\text{Cu}_2\text{S}$ , chalcopyrite  $\text{CuFeS}_2$  and bornite  $\text{Cu}_5\text{FeS}_4$ . Sulphide minerals exposed to air, water and substances therein have formed copper oxides. The occurrence is therefore near the surface. The most important are Cuprite  $\text{Cu}_2\text{O}$ , malachite  $\text{Cu}_2\text{CO}_3(\text{OH})_2$  and azurite  $\text{Cu}_3(\text{CO}_3)_2(\text{OH})_2$ .

About 78 % of the world's copper is produced from sulphide ores; about 22 % from oxidic copper.

Native copper occurs in the oxidation zone of certain weathered copper ores along with cuprite, malachite and azurite. The mineral has also been found in cavities of certain basalts and conglomerates. Although uncommon, one can find lumps of pure copper in areas with a rich occurrence of native copper. The best copper crystal forms have been found in the Keweenaw Peninsula in Michigan.

Small amounts of soluble salts of divalent copper are found in sea water. The copper content is very low, no more than  $10^{-4}$  g/t.

The principle areas with a rich occurrence of copper are Chile, USA, Peru, Central Africa, Russia, Canada, Mexico, China and Indonesia.

## Mining and ore processing

The occurrence of copper is not concentrated to certain geographical areas but is found in many countries, on all continents. Non is the mining of copper the economic privilege of a few nations but takes place all over the world. However, over 55 % of the total volume mined in the world today comes from Chile, China, Peru and USA. A large part of the copper mined today comes from deposits with a low content of copper. Only 4 to 10 kg of pure copper is extracted out of every ton of ore mined. The size of the deposits however makes it economically viable to mine the ore.

Concentration and smelting processes were earlier situated close to the raw material deposits whereas refining was usually located near the markets. Today there are also refineries near the deposits or, at the energy source. Several of the earlier ore exporting countries, e.g. Chile, Peru, and Zambia have now built their own refineries which means that these countries now have become major exporters of refined copper. Today China has become the world leader in copper smelting and refining, as well as fabricating copper semis and copper alloy semi-products.

Multinational corporations such as Rio Tinto, BHP, Anglo American and Chile's Codelco dominate all phases in the production of copper, from mining to the pure metal.



Drilling in a copper mine.

# Supply and demand

Copper has never been a rare metal or a metal difficult to obtain, and mining has expanded as new deposits have been discovered. There has been a continuous development of mining technologies and processes like the Outotec flash smelting process that have contributed to more efficient production.

Copper trading is a huge and international business mainly conducted via the London Metal Exchange (LME) where prices fluctuate daily depending on supply and demand.

During the 20th Century demand and production soared and this development continues. The total amount of copper used through the ages up to 1900 would not cover the current yearly demand. In spite of the high consumption level the world's reserves of copper have increased fivefold in the last 60 years and the indications are that this trend will continue.

The annual world production of mined copper amounts to about 16 million t. World reserves of economically recoverable deposits are currently estimated at 550 million t. Total known reserves are estimated at 1,000 million t. The annual resource usage level is currently about 16 million t and is expected to increase by a few percent per year. Although copper reserves are not unlimited, supply seems assured for the foreseeable future for all those fields of application where its properties are sought.

The copper we mine today is an investment for the future. It is not just a raw material to use and scrap – but a raw material to be used, scrapped and used again. The recycling of copper is almost total. Recycled (secondary) copper has the same mechanical properties as new (primary) copper.

Of the total almost 20 million t of refined copper produced annually, over 3 million are from recycled sources. It is worth noting that a large part of the world's recycled copper never goes for refining but is re-used after smelting for purposes which do not demand a raw material with the purity of refined copper.

In 2011 the total quantity of recycled copper, refined and non-refined, actually amounted to over 8 million t per year. This means that the amount of recycled copper already today constitutes 1/3 of the total world consumption.

The principles for recycling copper are steadily gaining ground around the world and the share of recycled copper will increase. Recycling is a relatively simple procedure. It requires much less energy than the refining of primary copper.

In the future the copper refining techniques will constantly be developed towards more ecologically sustainable methods. Recent trends include increasing share of aqueous solution techniques and the addition of soil bacteria to break down the copper ore.



Brass scrap for recycling.

# Environmental considerations

Copper production was earlier a big problem from an environmental point of view. Emissions, especially of sulphur dioxide (SO<sub>2</sub>), were high and emission of metals common. Big improvements have been achieved by operating closed processes.

A number of alternative metallurgical smelting processes have also been employed. The most common is flash smelting. It was developed by Outokumpu in Finland in the 1950s and is today used in 60 % of all copper production. The process is considerably less energy consuming and more in balance with the environment than older methods. Another alternative process under development utilises the ability of soil bacteria to break down ore. The result is a solution, rich in copper, which can be directly subjected to electrolysis.

## THE DIFFUSION OF COPPER INTO THE ATMOSPHERE AND SEAS

A preliminary estimate of the natural global diffusion of copper shows that some 28,000 t enters the atmosphere by way of natural processes annually, mainly due to volcanic activity and wind erosion of topsoil. The same quantity is emitted to the atmosphere due to human activities.

The quantity which is diffused into the seas by way of natural processes has been estimated at over 1,200,000 tons. This is thought to be four times as much as that emitted due to human activities. Human activities dominate when it comes to the emission of copper into the earth. Mainly by depositing coal ashes, gangue, concentration sand and sludges, by use in agriculture and as a result of atmospheric downfall.

Attempts have been made to estimate the environmental impact of copper caused by human activities by analysing drill cores from deep in the Greenland ice mass. With this method the total downfall due to human activities has been estimated at 2800 tons during the pre-industrial era. Since then another 200 tons have been emitted over Greenland. The reason for the high

level of emission in the pre-industrial era (with factors up to 15 %) is believed to be due to the primitive production processes used at that time. Industrial copper production processes today cause emissions with a maximum factor of 0.25 %.

## A biological and medical perspective

Copper is an essential micro-nutritional substance in all living organisms. Human beings, animals and plants need copper for growth and healthy development. New-born infants are bearers of 5–10 times more copper than adults, as a life insurance for growth, immunity, etc.

The daily requirement of adults is 0.9 mg. A varied diet of food and drink will normally cover this need. Food rich in fats is however deficient in copper and World Health Organization see a potential risk of copper deficiency among people in the western world due to poor eating habits.

Animals too obtain copper via their normal diet, but during fattening they are often given copper enriched fodder. Cattle will be given mineral supplements containing copper if there is any suspicion of copper deficiency. The so-called elk disease is believed to be directly linked to copper deficiency.

The soil of grain- and vegetable fields is impoverished if not supplemented with trace elements of copper and zinc. Stubble burning was earlier practised to enrich the soil but today copper is added together with fertiliser.

Copper compounds have been used for thousands of years as medicine and to sterilise drinking water. Copper for water tubes have proven to be a superior material when it comes to limiting the growth of micro-organisms, both bacteria and virus, in the tubes system.

Cases of copper poisoning are very rare in medical literature although it is not uncommon for potable water to contain levels of copper exceeding the limit of 2000 mg/l. Levels of that magnitude will only occur in connection with corrosion in the tube and if the water quality is unfit in all other respects (hardness, alkalinity, pH).

## COPPER AS THE ESSENTIAL NUTRIENT

After copper is ingested, it is absorbed in the stomach and small intestine. It is absorbed from the stomach and small intestine to the bloodstream. In the bloodstream it is bound to carrier proteins and is delivered to the liver. From the liver, it is distributed throughout the body to places where it is needed.

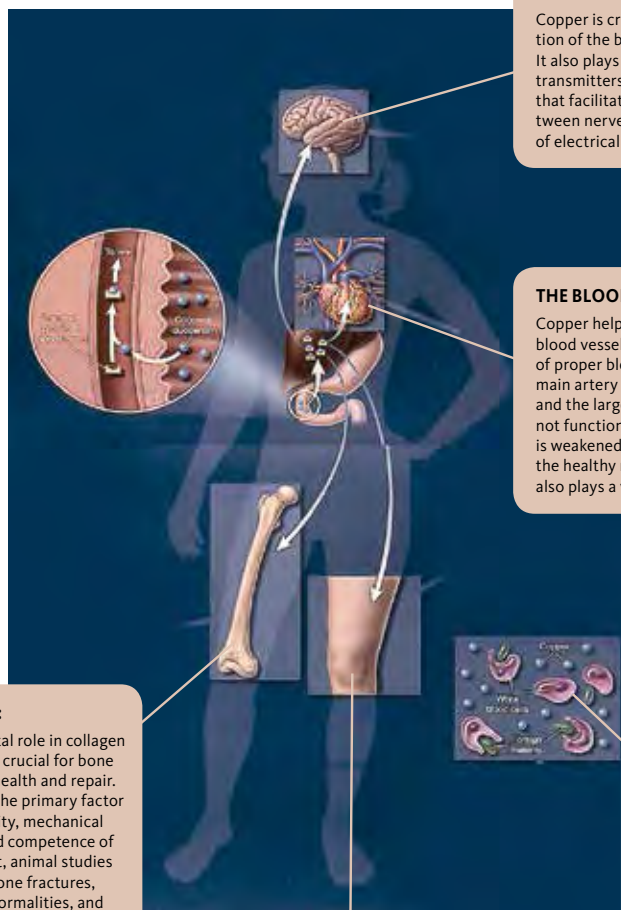

### THE BRAIN:

Copper is crucial for the normal formation of the brain and nervous system. It also plays a role in making neurotransmitters, the chemical messengers that facilitate communication between nerve cells, and the movement of electrical impulses along nerves.

### THE BLOOD VESSELS AND HEART:

Copper helps to sustain the elasticity of blood vessels, which allows maintenance of proper blood pressure. The aorta - the main artery that runs from the heart, and the largest in the human body - cannot function fully if its elastic framework is weakened. Since copper is needed for the healthy muscle tone and function, it also plays a vital role in the heart.

### THE BONE:

Copper's vital role in collagen formation is crucial for bone formation, health and repair. Collagen is the primary factor for the rigidity, mechanical strength and competence of bone. In fact, animal studies show that bone fractures, skeletal abnormalities, and osteoporosis occur with copper deficiency.

### THE SKIN:

Copper plays an important role in collagen formation, a connective tissue in the skin. Collagen is the most prevalent protein found in human skin and is important in maintaining our appearance - supply, healthy appearing, wrinkle-free skin - on our faces and all other areas.

### THE IMMUNE SYSTEM:

Copper is necessary for the maintenance of a healthy immune system to ward off germs and diseases. A strong and aggressive supply of germ-fighting soldiers, including white blood cells (engulf foreign material), antibodies (protein molecules), cytokines (chemical messengers), B lymphocytes (produce antibodies) and T lymphocytes (immune cells), keep the body healthy and disease-free.

## COPPER IS ESSENTIAL FOR:

- » Bone growth and strength
- » Fetal and infant development
- » Development of red and white blood cells
- » Transport and absorption of iron
- » Proper heart and muscle movements
- » Development of brain and nervous system
- » Protection of the body against tissue damage by acting as an antioxidant

Copper is available from a wide variety of fresh and lightly processed foods. Eating a well-balanced diet helps you to meet the National Academy of Sciences' new Recommended Dietary Allowance (RDA) for copper. Adults should get 0.9 milligrams (mg) of copper daily. Pregnant women need 1.0 mg and nursing women need 1.3 mg of copper. Here's how to satisfy copper needs with food.

### Copper RDA

Adults	0.9 mg
Pregnant woman	1.0 mg
Nursing mothers	1.3 mg

### FOOD Copper/mg

Vegetables	
Blackeyed Peas (cooked 1/2 cup)	0.234
Lima Beans (cooked 1/2 cup)	0.198
Navy Beans (cooked 1/2 cup)	0.241
Mushrooms (canned 1/2 cup)	0.187
Potato (baked w/peel)	0.140
Green Peas (1/2 cup)	0.081
Tomato (raw medium)	0.087

Fruit/Nuts	
Avocado (raw 1 medium)	0.527
Banana (raw 1 medium)	0.150
Grapes (raw 1 1/2 cups)	0.164
Mango (1 medium)	0.228
Raisins (dried 1/2 cup)	0.114
Peach (1 medium)	0.067
Almonds (1/4 cup)	0.394
Pecans (1 oz package)	0.306
Peanuts (1/4 cup)	0.500
Peanut Butter (2 tbsp)	0.178
Sunflower Seeds (1/4 cup)	0.600
Trail Mix (1 cup)	1.478

Grains/Breads	
Oatmeal (cooked 1 cup)	0.199
Granola with Raisins (1/2 cup)	0.224
Raisin Bran (1 cup)	0.281
Shredded Wheat (2 biscuits)	0.206
Whole Wheat Bread (2 slices)	0.055
White Bread (2 slices)	0.055
Rye Bread (2 slices)	0.112
Noodles, Egg, Enriched (1 cup)	0.139

Fish/Meat	
Oysters (breaded/fried 6)	0.796
Shrimp (3 oz)	0.191
Beef/Calf Liver (pan-fried 3 oz)	6.15
Beef Steak (pan-fried 8 oz)	0.093
Tuna (canned 4 oz)	0.052
Chicken (baked 3 oz)	0.054

Mixed Dishes	
Chili (with Beans, canned 1 cup)	0.372
Lasagna (7 oz)	0.208
Spaghetti & Meat sauce (1 cup)	0.265

Dessert	
Chocolate Ice Cream (1 cup)	0.086
Milk Chocolate (1 1/2 oz)	0.175

Sample Meal Breakfast	
1 cup Oatmeal	0.199
1 cup Skim Milk	0.007
1/2 Med. Banana	0.075

Lunch	
2 slices of White Bread	0.055
4 oz Tuna (canned)	0.052
8 oz Apple Juice	0.027

Snack	
1 Med. Peach	0.067

Dinner	
6 oz Lean Baked Chicken	0.108
1 small Baked Potato	0.140
1/2 cup Green Peas	0.081
1 cup Skim Milk	0.007

Dessert	
1 cup Chocolate Ice Cream	0.086

**TOTAL: 0.904 mg Copper**

Sources: Duyff, Roberta L., MS, RD, CFCS. The American Dietetic Association's Complete Food & Nutrition Guide. Chronimed 1996; 99  
 Pennington, J.A.T., S.A. Schoen, G.D. Salmon, B. Young, R.D. Johnson and R.W. Marts. 1995. Composition of core foods in the U.S. Food Supply, 1982-1991. III. Copper, manganese, selenium, and iodine. J. Food Comp. Anal. 8: 171-217. (Data from US FDA Total Diet Study)  
 U.S. Department of Agriculture, Agricultural Research Service. 1999. USDA Nutrient Database for Standard Reference, Release 13. Nutrient Data Laboratory Home Page, www.nal.usda.gov/fnic/foodcomp



# Processing

# From copper ore to copper sheet

About 80 % of the world's primary copper is produced from sulphide ores such as chalcopyrite  $\text{CuFeS}_2$ .

The ore that is used for the production of copper contains on average 1 % pure copper. A long process waits before the raw material has been converted to the copper material from which copper sheet is made.

A typical process:

The copper ore is crushed into a fine powder. The copper is separated using a flotation process. An alternative process is a so called heap leaching and solvent extraction process. Copper concentrate, the intermediate product contains about 20–45 % copper.

The concentrate is mixed with Silica sand and fed into a flash smelting furnace (FSF). Outokumpu flash smelting process takes advantage of the combustion heat of sulfidic concentrates, which are smelted by oxygen enriched air in a flash smelting furnace. Sulphur is burned to sulphur dioxide gas and iron is oxidized and slagged to iron silicate together with silica sand. Ore concentrates (60–70 % Cu) is an intermediate product of the copper smelter.

Iron in the ore concentrates is oxidized in the slag blowing stage of the converting process by oxygen enriched air (about 25 %  $\text{O}_2$ ). In this stage oxidized iron together with added silica flux form a fayalite slag, which floats on the top of the copper rich white metal ( $\text{Cu}_2\text{S}$ ). The white metal contains about 78 % copper and less than 1 % iron. After that the sulphur of the white metal is oxidized in the copper blowing stage. The main product of converting is blister copper, which contains about 0.02–0.1 % S and about 99 % Cu.

The melt is further refined in an anode furnace and cast into anodes. These anodes are electrolytically refined. The final product, cathode copper has a purity of 99,95–99,99 %.

Cathode copper is today the most common form of traded copper. It is normally converted into commercial semi-manufactured cast products such as wire rod, cakes, billets and ingots and further drawn, extruded, forged or rolled into final products.

## MELTING AND CASTING

To produce alloys, copper is melted together with other metals. The state of the art casting method is continuous casting where the metal is allowed to solidify in a water cooled bottomless mould. The solidified metal is pulled out slowly with a set of pinch rollers and new melt flows into the mould. In this order the continuously cast product is cut into required lengths or thin strip is coiled for direct cold rolling.

## SHEET AND STRIP PRODUCTION

The purpose of hot rolling is to make the cast cake thinner so that it can be coiled and on the other hand to refine the grain structure from casting by recrystallization occurring during or after each rolling pass. The surface oxidises during the hot rolling process and this has to be removed before the sheet is cold rolled. In a similar way the as cast surface of a cast strip is milled for a smoother, more attractive surface. Cold rolling and intermediate annealing are used to give the strip or sheet the final thickness and temper.

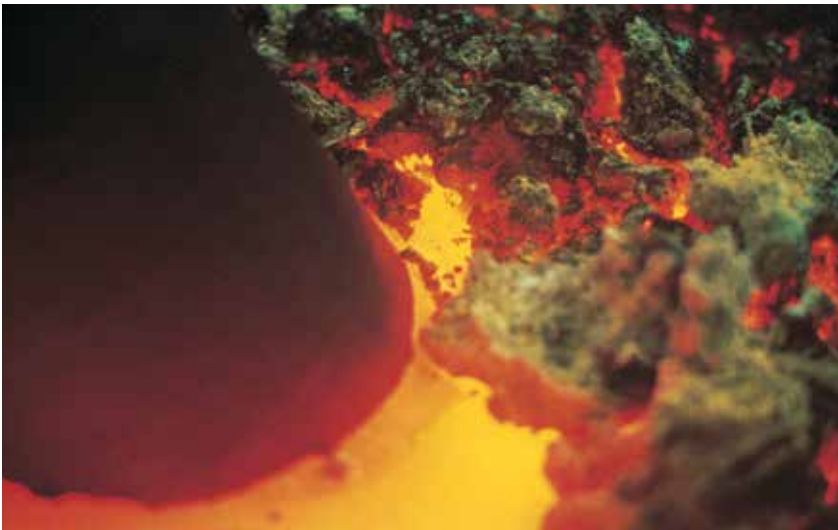

# Recycled copper

About two thirds of all copper used by the major industrial countries is needed for applications which require primary copper of grade “A” quality. Alloys such as brasses and bronzes account for much of the other copper. Only a small part of the copper used in major industrial countries goes into chemicals, pesticides, fungicides etc. In other words, copper applications are dominated by fields where recycling is relatively simple.

The production of primary copper is energy intensive, particularly if the copper is extracted from poor ore with a copper content of 0,5 % or less. The production of secondary copper, where scrap copper is the source, is far more energy efficient as many of the energy intensive processes such as mining, crushing and concentration of copper ore are not needed.

When the copper products have come to the end of their usefulness, such as wire, roof-sheets, panels or drainpipes, the copper is still of a high value. This is a strong incentive for the recycling of surplus material.

The source of scrap copper, its purity and quality puts different demands on the processes and energy requirements needed to produce a secondary copper of required quality. Generally speaking the purest scrap quality, the so-called “No.1 Scrap” which contains uncontaminated copper or 99 % Cu, needs no or little refining. The “No.2 Scrap” quality which contains a minimum of 94–96 % Cu usually goes to the anode furnace and thereafter to electrolytic refining. Contaminated copper alloy scrap needs to be processed in a converter before it can go to anode production. Scrap contaminated beyond acceptable limits is refined using modern secondary metal refining techniques.

The average energy consumption in the production of secondary copper is estimated at 15–40 % of that of primary copper. There is a significant difference in the energy consumption between No.1 scrap and No. 2 scrap.

In society today, sophisticated methods are required for dealing with all the scrap we produce. The metal value and the opportunities to use simple processes to refine copper to its original level of quality mean that copper is a leading material when it comes to recycling. Nowadays, for example in Europe, around 45 % of the total consumption of refined copper is scrap-based. And this figure is steadily on the increase. As far as copper sheeting intended for construction purposes – what is known as construction sheet metal – is concerned, the figure for recycling now stands at almost 100 %.



Copper can be recycled to a very high degree (up to 90 %) in fact, 80 % of all copper ever extracted is still in use today.





Piliscsaba Budapest,  
Hungary

# Properties



Copper used for roofs is primarily of the phosphorus deoxidised type.

## Pure copper and copper alloys

Commercially copper is sold in varying classes of purity, which are defined by standards applicable on the market. The variations are dependent upon oxygen content, impurities and the refining process used during its manufacture.

In the most common method for the production of copper from copper ore, a certain amount of oxygen is taken up which forms  $\text{Cu}_2\text{O}$  and gives rise to an alloy with the copper. This oxide has no adverse effect on the electrical conductivity of the copper; quite the opposite, it may improve this given that impurities present in the metal may bond with the oxygen to form oxides. However, if the metal is later heated in a hydrogen-rich atmosphere, this can result in the formation of blisters – or hydrogen embrittlement – due to the water vapour which is formed when hydrogen diffuses into the oxygen containing metal. To counteract this, a deoxidant is added; normally phosphorus, which does, however, slightly reduce the conductivity of the copper. Other deoxidants include boron, calcium and lithium.

Another method is to melt the metal and then cast it without any oxygen being taken up. One result of this production principle is electrolytic copper. This is used primarily for purposes which demand the maximum possible electrical conductivity, such as in electronic applications.

Refined copper does not have the same excellent conductivity of electrolytic copper, but it is very appropriate for use as construction sheet metal and is commonly used as a roofing material.

The main qualities of copper in the “pure copper” group are as follows:

### **OXYGEN-FREE HIGH CONDUCTIVITY COPPER, “OFHC” (CU-OF)**

Purity 99.95 %, oxygen uptake avoided during refining. Contains no impurity. This copper is not susceptible to hydrogen embrittlement. Electrolytic copper is an oxygen-free high conductivity copper, produced by melting of cathodes and cast in a protective atmosphere which prevents the metal from taking up oxygen.

### **OXIDISED COPPER, “HIGH-CONDUCTIVITY TOUGH-PITCH” (CU-ETP)**

Purity 99.9 %, contains traces of cupric oxide. The reason for the oxygen content, approx. 0.02 % oxygen, is so that it is possible to utilise a simple melting and casting technique when manufacturing workpieces. The disadvantage of the oxygen is that it makes it necessary to avoid heating, welding or soldering the copper in a reducing atmosphere as the oxygen together with hydrogen in a furnace atmosphere or flame forms water vapour, which can rupture the metal. This copper would be affected by hydrogen embrittlement.

### **DEOXIDISED COPPER (CU-DLP; CU-DHP)**

As a rule, deoxidised copper contains a few thousandths of a percent of phosphorus. It is possible to deoxidise the copper using substances other than phosphorus, such as boron or lithium. Phosphorus is added in order to bind oxygen in the metal and to make the copper non-susceptible to hydrogen embrittlement. The phos-

phorus is normally 0.003 % – 0.020 % of the total material composition. The more phosphorus that is added, the lower the conductivity of the metal, and its ability to withstand hydrogen embrittlement is increased.

The impurities in copper metal and copper alloys which create the greatest problems from the point of view of quality are antimony, bismuth and lead, and therefore the amounts of these elements in the metal must be kept extremely low.

A significant quantity of the copper used nowadays is found in various alloys. At one stage, up to 500 different alloys containing copper were manufactured in the USA. Brass is normally referred to as a copper-zinc alloy, and bronze is referred to as a copper-tin alloy. Actually, such alloys often contain a very large proportion of other elements. The commercial bronze alloys currently in use contain, in addition to copper and tin, small and varying proportions of zinc, iron, nickel, cobalt and phosphorus. The presence of these substances in specific quantities in alloys gives them certain properties and makes them suitable for various technical applications.

The main classes of alloys containing copper are as follows:

### **LOW-ALLOY COPPER**

Additives to the copper generally result in a reduction in its conductivity. The copper is alloyed with small quantities of one or more substances in order to attain specific properties without altering its basic character. Adding tin, iron or chromium makes the copper stronger. Sulphur or tellurium improves its cutting properties. Adding silver, cadmium, tin or tellurium increases the softening temperature and improves its creep strength.

### **BRASS**

Consists mainly of copper and up to 45 % zinc. Alloys containing 36 % up to 37 % zinc (alpha brass) are ductile when cold and are highly workable. Brass containing more than 37 % zinc (alpha-beta brass) is harder and stronger than alpha brass, which makes it more difficult to cold-work. Beta brass is normally selected for hot-working. Lead is added to alpha/beta brass in order to

improve its cutting properties, while adding aluminium, iron or manganese to beta brass results in greater tensile strength and improved corrosion resistance. One example of this is what is known as “bearing brass”, which is used in gearboxes.

### **NICKEL BRASS**

An alloy of copper, zinc and nickel. Nickel brass is also usually known as nickel silver (EPNS) on account of its silverlike colour. This alloy often replaces silver as the base metal in cutlery, kitchenware, etc. However, it is mostly used on account of its deeper qualities, good strength and great corrosion resistance.

### **BRONZE**

This name was originally reserved for copper-tin alloys. However, modern “bronzes” may also contain aluminium, manganese, silicon or zinc, instead of tin.

### **TIN BRONZE**

The usual proportions of tin found in tin bronze alloys are 4 %, 6 % and 8 %. These bronzes also contain phosphorus for the purposes of deoxidation.

These alloys are easy to cold-work and are normally handled in strip form or as wire. When cold-worked, they are very strong, and this strength increases in proportion with the quantity of tin in the alloy. Good mechanical properties, good corrosion resistance allow these alloys to be used as spring and contact materials in electrical apparatuses and in the field of electronics.



Brass – for internal use.



## ALUMINIUM BRONZE

Aluminium bronze has an aluminium content of between 5 % and 10 %. Aluminium bronzes are characteristically very strong, and this strength increases in proportion to the quantity of aluminium in the alloy and can be further reinforced by adding iron, manganese, nickel or silicon. This metal is extremely resistant to corrosion, as well as to oxidation under high temperatures. Its abrasion resistance is also good. Aluminium bronze is used in marine application and coins.

A few other bronze alloys are manufactured, although to a lesser extent, normally with the addition of manganese, silicon or chromium.

## BERYLLIUM COPPER

The addition of 1 %–2 % beryllium results in a high-class spring material which is very strong. Beryllium copper is the strongest copper alloy.

## CUPRO-NICKEL

This is made up of copper alloys containing up to 30 % nickel, sometimes with iron or manganese added. These additions result in great strength and improved resistance to corrosion, primarily impingement attacks.

This metal is used for the manufacture of pipes and in components for condensers and heat exchangers; especially in conjunction with salt water. Over the last few years, the use of cupro-nickel has become more widespread for marine applications and in the offshore industry. It has long been used for the manufacture of coins.



Copper facade Basel Switzerland.

# Material properties of Cu–DHP

The copper used for roofs and facades is primarily of the phosphorus deoxidised copper type designated Cu–DHP in accordance with EN 1172 (European standard covering sheet metals and strips for construction purposes).

Cu–DHP is a metal with good properties for standard forming and working. Annealed copper sheet is used for roofing by the traditional sheet covering method and for demanding applications, seaming, etc. As a rule, half-hard sheet metal is used for strip roofing and for mouldings, plates and similar where material rigidity is important.

Hard material is recommended for the manufacture of cassettes and profiled sheeting.

The table below shows values relating to the temper and dimensions for copper sheeting and strips designed for construction purposes.

For detail information on standards and dimensions, see page 69.

MECHANICAL PROPERTIES										EN 1172
Designation		Material condition	Tensile strength		0,2 % proof strength		Elongation	Hardness		Trade designation
Symbol	Number		$R_m$ N/mm <sup>2</sup>		$R_{p0,2}$ N/mm <sup>2</sup>		$A_{50\text{ mm}}$ %	HV		
			min.	max.	min.	max.	min.	min.	max.	
Cu-DHP CuZn0.5	CW024A	R220	220	260	–	140	33	–	–	annealed
		H040	–	–	–	–	–	40	65	annealed
	CW119C	R240	240	300	140	–	8	–	–	semi-hard
		H065	–	–	–	–	–	65	95	semi-hard
		R290	290	–	250	–	–	–	–	full-hardness
	H090	–	–	–	–	–	90	–	full-hardness	
CuSn 0.15	CW117C	R250	250	320	200	–	9	–	–	
		H060	–	–	–	–	–	60	90	
		R300	300	370	250	–	4	–	–	
		H085	–	–	–	–	–	85	110	
CuAl5Zn5Sn1	CW309G	R400	400	–	170	–	45	–	–	
		H080	–	–	–	–	–	80	–	
CuSn4	CW450K	R290	290	390	–	190	40	–	–	
		H070	–	–	–	–	–	70	100	
CuZn15	CW502L	R310	310	370	200	290	10	–	–	
		H090	–	–	–	–	–	90	115	

PSYSICAL PROPERTIES OF Cu DHP	
Density	8,9 g/cm <sup>3</sup>
Melting point	1083 °C
Specific thermal capacity at 20°C <sup>1)</sup>	0,385 kJ (kg °C)
Coefficient of linear expansion at 20–100 °C	16,8 x 10 <sup>6</sup> °C <sup>-1</sup>
Coefficient of linear expansion at 20–300 °C	17,7 x 10 <sup>6</sup> °C <sup>-1</sup>
Modulus of elasticity	118 000 N/mm <sup>2</sup>
Shear modulus	44 000 N/mm <sup>2</sup>
Electrical conductivity at 20 °C <sup>1)</sup>	ca 52 MS/m / ca 90 % IACS <sup>2)</sup>
Thermal conductivity at 20 °C <sup>1)</sup>	ca 365 W/(m °C)
Resistivity at 20 °C	ca 20 nΩ m
Temperature coefficient for resistance at 20 °C	0,00275 °C
...for resistance at 0–100 °C	0,00354 °C

1) Applies to annealed metals

2) IACS = International Annealed Copper Standard.

100 % IACS is equivalent to a resistivity of 17.241 nΩ m and a conductivity of 58 MS/m.

## HEAT TREATMENT OF CU-DHP

Stress-relieving:

Temperature 200 °C –250 °C. Time approx. 1 hour

Soft annealing:

Temperature 350 °C –50 °C. Time 0.5–3 hours.

The recrystallisation temperature is normally in the range approx. 300 °C –350 °C.

## WORKABILITY OF CU-DHP

The hot-workability of this metal is very good. The recommended temperature is 750 °C – 900 °C.

The cold-workability of this metal when annealed is very good. Its workability decreases as it work hardens.

## CUTTING PROCESSING OF CU-DHP

A high surface quality can be attained if the recommended tool geometry and the recommended cutting data are observed. It is necessary to bear in mind the fact that this metal has a tendency to leave deposits on the tools and give rise to the formation of rough edges. Working at high speed and with a high feed will counteract such tendencies. The swarf is long and tough. In the case of soft metals, there is a risk of pliable workpieces bending or being twisted. In general, there is more chance of attaining a high surface quality if the metal is harder.

## WELDING AND SOLDERING OF CU-DHP

This metal can be welded and soldered. However, the high thermal conductivity can make it more difficult to heat up the joint as the heat is easily dissipated from this point, particularly in the case of rough pieces.

Therefore, it may be necessary to pre-heat the workpieces.

The following welding and soldering methods may be used:

- » Gas welding – easy
- » Metal arc welding – difficult
- » Gas-shielded arc welding – very easy
- » Spot and seam welding
  - possible at metal thicknesses of less than 1.5 mm
- » Butt welding – easy
- » Flash welding – possible
- » Braze welding – very easy
- » Hard soldering – very easy if silver solder, silver phosphor copper solder and phosphor copper solder are used
- » Easy if brazing solder is used
- » Soft soldering – very easy

For more information on welding and soldering, see also under TECHNOLOGY in the chapter on welding and soldering, pages 139–148.

## CORROSION / SERVICE LIFE

In the case of roofs and facades made of copper, an exceptional service life and durability can be expected. The overall impression in respect of damage and wear in connection with the use of copper sheeting is that it is the fixings which are the weakest point. In the case of repairs to and inspections of old roofs, the sheet metal has often been in good condition while the fasteners have been in need of replacement.

The corrosion resistance of copper outdoors is very good. Essentially, there are three different types of corrosion.

## GENERAL CORROSION

The most common type of corrosion is, normal erosion from the surface. The fact that the rate of corrosion is very low is corroborated by both controlled series of experiments and long periods of practical use.

## AVERAGE CORROSION OF COPPER

( $\mu\text{m}/\text{year}$ )

Rural atmosphere 0.2–0.6 per annum

Marine atmosphere 0.6–1.1 per annum

Urban atmosphere 0.9–2.2 per annum

Greater corrosion can occur under unfavourable conditions, such as when the metal is affected by acid water.

Pools of water caused by poor drainage can also lead to local corrosion.

## CORROSION COMPARISON

General corrosion ( $\mu\text{m}/\text{year}$ )

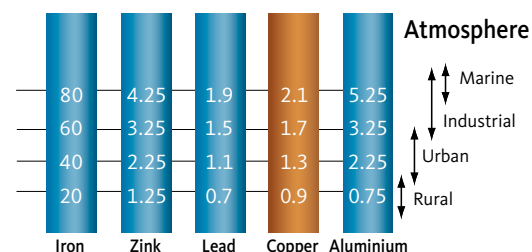

## GALVANIC CORROSION

This does not normally lead to copper being attacked, as copper is usually the nobler of the metals which normally come into contact with one another in structures. However, copper can cause galvanic corrosion in less noble metals such as aluminium, zinc or iron. Therefore, contact between these metals should be avoided, and water which has been in contact with copper should not be permitted to run down onto other metal surfaces.

## EROSION CORROSION

Corrosion damage can occur over time at points of contact where water runs down onto copper surfaces. As a rule, this is due to the fact that the water is acid and that the contact point is constantly being abraded by the running water so that no protective oxide layer is able to form. Even greater abrasion will occur if the water also contains granules of sand.

To prevent erosion corrosion on gutters in areas where acid rain falls, it is necessary to observe the principles for the drainage of water when laying or fitting roofs, and it is suggested that a sacrificial plate also be fitted over any obvious points of contact with water.

## COPPER IN CONTACT WITH OTHER METALS

Copper is one of what are known as the noble metals, which is why galvanic corrosion does not normally lead to damage to the surface of the copper. As it is a noble metal, copper can, just like other noble metals, cause galvanic corrosion to other, “less noble” metals such as aluminium, zinc and iron. Therefore, building structures should be designed in such a way as to avoid contact – both direct and indirect – between these metals.

If it is desirable to use copper in combination with aluminium, for example, an electrical, non-conductive surface coating should be applied to the surface of the aluminium, known as anodising, thus making it resistant to the corrosive substances from the copper sheet. The water which runs off copper surfaces should be drained off in such a manner that it does not touch any sections containing “less noble” metals.

## COPPER IN CONTACT WITH OTHER BUILDING MATERIALS

Local damage can occur in the form of what is known as erosion corrosion due to shortcomings in detail design, for instance where water and particles of sand constantly leak out and drip down onto underlying copper sheeting, thus abrading the protective surface layer.

It is inappropriate to place copper sheeting in direct contact with bituminous surfaces on account of corrosion. Acid rainwater in concentrated form from a bituminous surface will prevent the development of the protective surface layer on the copper sheeting. In the long term, this will lead to discoloration and damage to the copper sheeting.

Facades made of non-water repellent materials such as plaster, sandstone, brick, wood, etc. should be protected against rainwater containing copper which could otherwise lead to discoloration. Flashings on plastered walls should be terminated with drip mouldings which run no less than 40 mm beyond the finished wall.



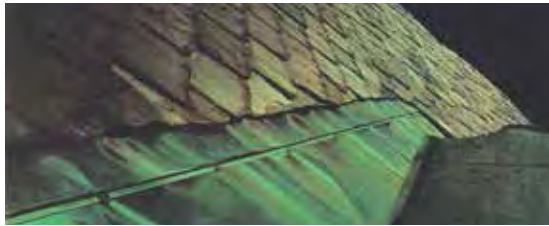

Sacrificial plate on a roof. To prevent erosion corrosion.

## NATURAL PATINA

The term patina (pátina) generally refers to things showing signs of old age, but it is also an accepted term for the coating which appears on old copper. It is sometimes known as green patina or aerugo nobilis. Nowadays, patina is particularly evident in architecture, particularly on very old copper roofs and facade elements.

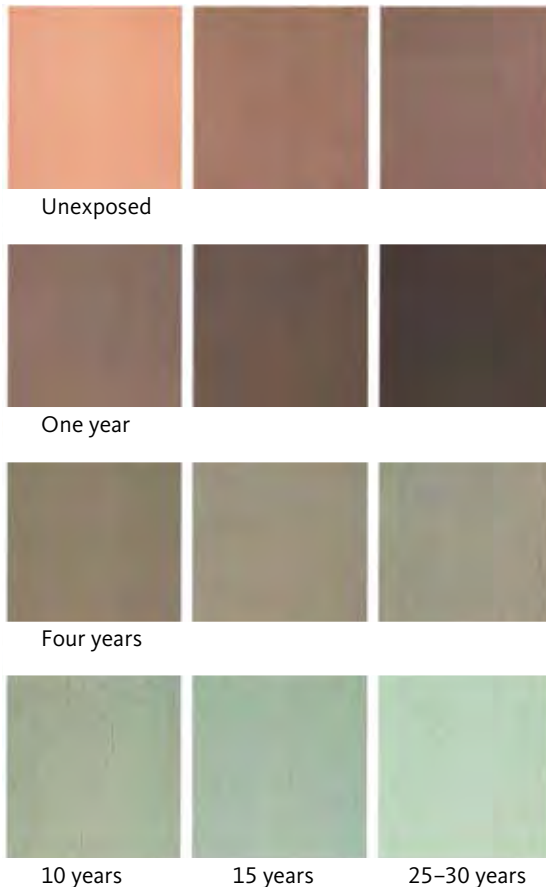

### Weathering of copper

This weathering cycle represents a copper roof at a 45° angle with a southern exposure in a typical European northeastern industrial city.

The use of copper – not only on monuments, but also on shops and homes – must largely be considered to be due to the distinctive and attractive display of colour which appears on the surfaces over time due to the effects of the wind and weather.

## FORMATION OF PATINA

When first fitted – as a rule during the first few weeks – newly laid copper sheeting may show clear, dark spots from the handling and working of the metal. Dark-coloured mottling may also develop on certain sections due to local atmospheric effects. Minor variances may occur between sheet metals of different hardnesses and textures. These variances usually even out after one or two years, and the copper surfaces take on a more even, dark brown colour which will not undergo any directly obvious changes over the next few years. However, gradually the green patina begins to appear. To begin with, this takes place primarily on horizontal and slightly sloping surfaces. It is not uncommon for the patina on vertical surfaces to develop considerably more slowly. Sometimes it largely fails to develop at all.

Patina is formed by means of the atmospheric corrosion of the copper; that is to say, by general corrosion. This process can be perceived as the tendency of the metal to return to its original ore state. Unlike the rust which forms when iron and steel corrode, the products of corrosion which form on copper have a certain protective effect.

The rate at which patina forms is therefore relative to the rate of corrosion. Long-term tests at various locations in Sweden have shown that this is as follows: approx. 0.5 micrometre year (one-thousandth of a millimetre) in a rural atmosphere (measured at: Erken in Uppland, Sweden)

approx. 1–2 micrometres per year in an urban atmosphere (measured at: Stockholm, Sweden)

approx. 1 micrometre per year in a sea atmosphere (measured at: Bohus Malmön, Sweden)

This means that it is possible to assume service life of the order of hundreds of years for ordinary, 0.6 mm thick copper roofing sheet under normal atmospheric conditions.

## CONDITIONS WHICH AFFECT THE DEVELOPMENT OF PATINA

When copper is exposed to rain and snow and airborne pollutants, what is known as an electrolytic film forms on its surface. This process produces copper hydroxide salts (basic salts) and is promoted by damp and humidity and a temperature which is not too high. A favourable pH and sufficient access to patina-forming substances in the surface moisture are particularly important.

It is possible to overview the thermodynamic criteria for the formation of patina in what are known as potential pH diagrams which show the stability ranges for copper, cupric oxides and copper hydroxide salts in aerated water. From these, it is possible to see, for example, that the sulphate and chloride patina in an urban atmosphere and a sea atmosphere can be expected to remain stable right down to a pH of around 4 in the surface moisture.

In composition, that part of the patina closest to the copper surface consists of dark oxide, primarily copper (I)oxide,  $\text{Cu}_2\text{O}$ . It is then coated with a green substance made up of copper hydroxide salts. The dominant component is a sulphate with the chemical designation  $\text{Cu}(\text{OH})_{1.5}(\text{SO}_4)_{0.25}$  with the exception of sea atmospheres, where the chloride  $\text{Cu}(\text{OH})_{1.5}\text{Cl}_{0.5}$  usually dominates.

A small element of copper hydroxide nitrate,  $\text{Cu}(\text{OH})_{1.5}(\text{NO}_3)_{0.5}$  and carbonate,  $\text{CuOH}(\text{CO}_3)_{0.5}$  may appear, as may more local elements of rust, soot and silicatic dust. In urban and rural atmospheres, the patina-forming substances are primarily made up of anthropogenic air pollutants such as sulphur and nitrates oxides. Chlorides are dominant in coastal areas.

## INTERACTION BETWEEN COPPER AND THE ENVIRONMENT

Copper is a trace element and vital to life for both animals and humans. It must also exist in the soil in order to permit healthy vegetation to grow. Thus small amounts of copper occur naturally in the world about us. Without copper, life in its present form could not exist. However, the principle of not providing the environment with overdoses of substances which are

important in themselves also applies to copper. The regulations of sewage works apply in this instance as preventive instructions against such over-fertilisation. However, the amount of copper released from copper roofs is very low (see figures on page 36) and contributes only a very tiny amount of the copper content of rainwater when it is processed by sewage works. Thus copper roofs can be regarded as an environmentally friendly alternative which also meets all the objectives and demands for good adaptation of the circulation of water.

## RUNOFF (AND CORROSION) FROM COPPER ROOFING

Copper has a long appropriate service life, thanks to its corrosion resistance, which exceeds that of most other roofing materials available on the market by a good margin. The pale green colour, or patina, which is typical of older copper, is a visible effect of the oxidisation which takes place when copper reacts with substances in the atmosphere. A certain amount of corrosion of the metallic copper takes place in connection with this reaction, which takes place whenever copper is placed outdoors. The depth of this corrosion is so marginal that during a relatively short working life, it is scarcely measurable, even in the most hostile urban and industrial atmospheres.



Copper roofs have an unbeatable lifetime. Nobody knows how old a copper roof can become. Malmö Town Hall, Sweden.

The green-coloured staining which sometimes appear in connection with the drainage of copper-coated surface are made up of green copper minerals, which are formed by the reaction of the copper with materials which contain carbonate (such as cement). According to surveys carried out by the Royal Institute of Technology in Stockholm, these deposits have very little or no effect on the environment.

In this context, it should be emphasised that corrosion in the case of copper is extremely low, and that most of the corrosion products formed are never transported away by rainwater and the like, but remain where they are on the surface in the form of oxides and patina.

The left figure below is based on measured corrosion rates and runoff rates from 1995 until today. Older runoff rates are calculated with a model developed at The Royal Institute of Technology, Division of Surface and Corrosion Science.

Right figure below is based on measurements regarding corrosion levels in relation to time and different types of atmospheric conditions.



When a copper roof is replaced, the metal value and the recycling of the scrap pay for a large part of the new roof.

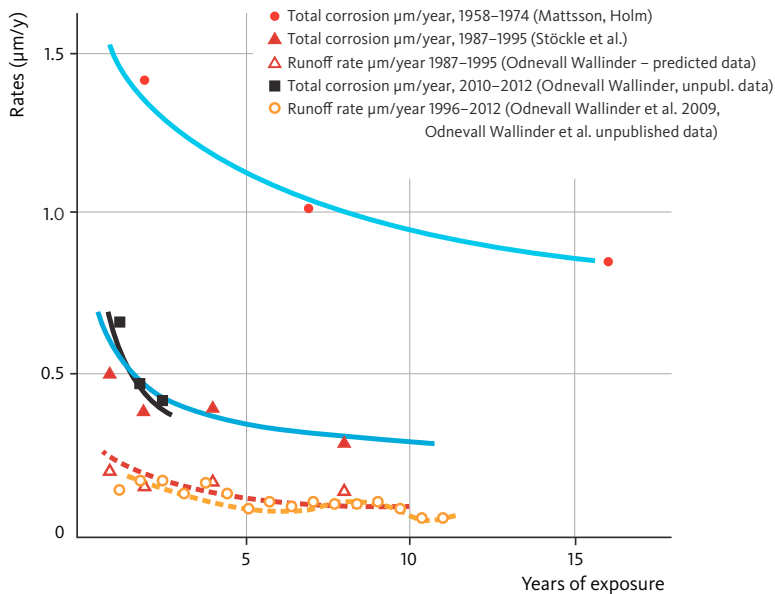

Corrosion rate of copper in Stockholm.

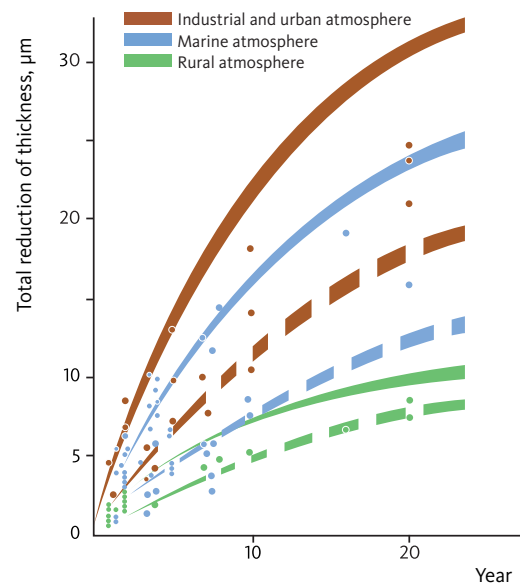

Areas where the thickness has been reduced (total corrosion = corrosion products remaining and flushed away) as a function of time for various climate types.



## COPPER IS PART OF ITS OWN INFINITE USER CYCLE

The enduring metal value of copper, which results from the fact that this is a metal which can be recycled and remelted as many times as required without losing its metal-specific properties, means that it goes without saying that copper can be recycled and reused. As early as the time when the Colossus of Rhodes collapsed and could not be rebuilt, the bronze outer plating of the statue was put to use by remelting it and reusing it for other, new purposes.

When whole life cycle of a building is considered, from cradle to end-of life, the period in use contributes the major share to life cycle impacts. Production phase life cycle impacts of materials used are insignificant compared to life time impacts. The full recyclability of copper reduces additionally the life cycle impacts, and contributes to waste minimizing.

It is thus important to consider functionality of copper as building material, durability without need for maintenance, and count for its properties, long life time and full recyclability. When making assessments for buildings throughout their life time, these aspects make a positive contribution that by far overrules the production impacts.

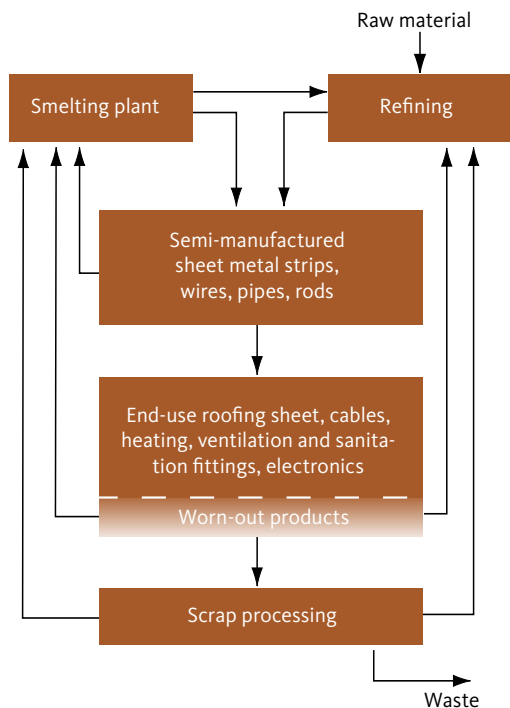

## ENERGY-SAVING PROPERTIES FOR BOTH FIRST-TIME USE AND RE-USE

Taking the long-term view, using long-lasting materials and taking care of the resources of our earth are essentials for our time. The resources of nature are not inexhaustible: quite the opposite in fact, they are limited and must not, therefore, be used up. The resources of our earth are only on loan to us.

From this point of view, copper seems to be a well thought out choice of material. It is a genuine and natural material, it is stable and never needs to burden society with costs for refuse collection or landfill. Instead, it can be recycled and reused again and again in a recycling process which is very energy-efficient. The average energy consumption for the production of one tonne of copper from ore is 20 MWh. When producing a similar quantity from scrap, only 2,5 MWh of energy are needed.



## Antimicrobial properties of copper

It has been known for thousands of years that copper protects from growth of mildew and algae. The ancient Romans used copper coins in their water pots to ensure hygienity. Today copper and copper compounds are used in for example anti-fouling paints to prevent barnacles' fastening to boat hulls and at vineyards to suppress the growth of fungus and mould.

Copper also prevents growth of harmful pathogens on touch surfaces. The antimicrobial properties of copper could be utilized more efficiently by using copper or its alloys on surfaces where bacteria and micro-organisms may grow and be transmitted. Traditionally brass has been used in keys, doorknobs and handrails, but many possible applications are still emerging. Copper has always been used in hospital water and medical gas supply systems because it secures hygienic supply of these vital elements. In hospitals around the world there have been made

case studies and test installations where the most frequently touched surfaces have been replaced by copper surfaces. Surfaces where there have been detected the highest loads of microbes, are the ones most frequently touched, including for example workstations, push buttons, pull and lever handles, bed rails, visitor chairs, table tops, trolleys and drip poles.

These studies prove that microbe levels can be reduced close to zero, and that spreading of infections factually can be reduced. It has been calculated that replacing the most critical touch surfaces in a patient room by copper costs much less than treatment of one single case of hospital acquired infection.

In addition there are evidences that copper surfaces prevent spreading of spores of mildew. It gives reason to believe that copper in ventilation and air conditioning channels and coils can have an effect to improve indoor air quality.

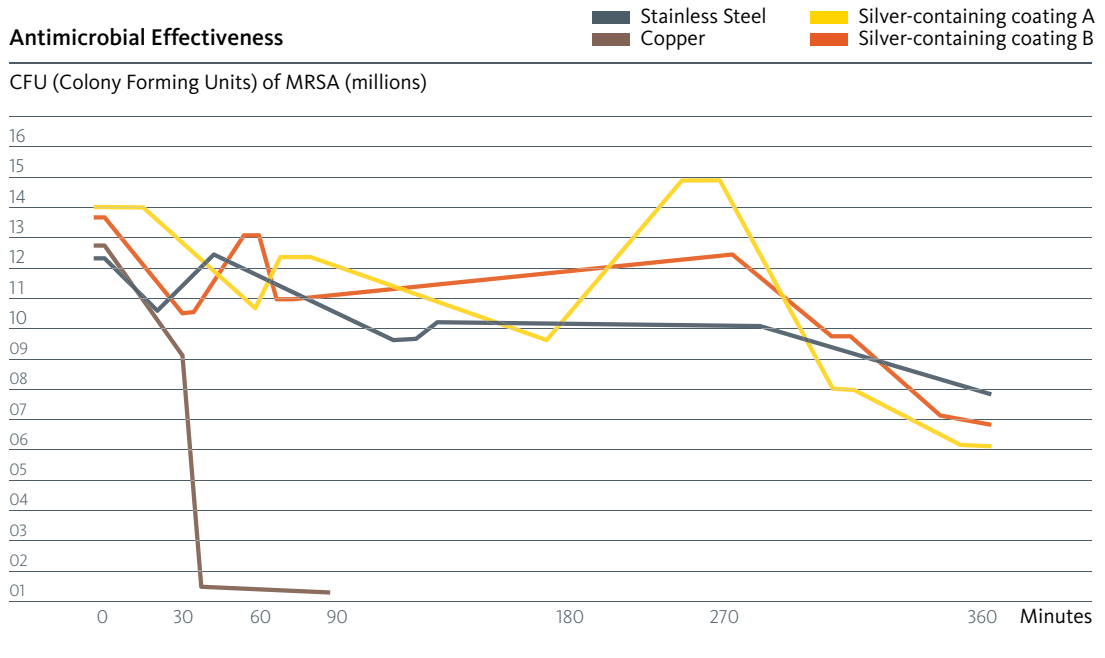

A linear scale kill curve of copper, two silver-containing coatings and stainless steel vs MRSA at room temperature and humidity. This clearly demonstrates copper's superior efficacy under typical indoor conditions but with an extremely high challenge of bacteria.

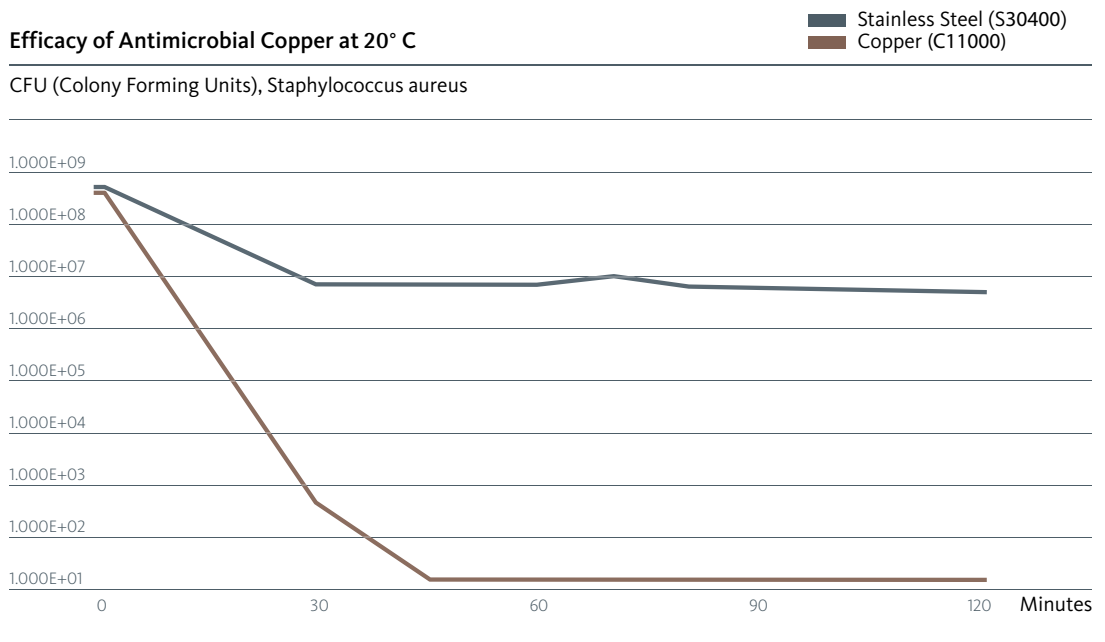

A log scale kill curve of copper and stainless steel vs MRSA at room temperature and humidity. This shows copper's rapid efficacy against MRSA under typical indoor conditions.



The Wasa Museum,  
Sweden

# Nordic Copper

surfaces / forms / systems





Tampere City Library (Metso), Finland, is an exuberant demonstration of copper's potential for freedom of architectural form, from the latter part of the 20th century.

Architects:  
Reima and Raili Pietilä

## COPPER ARCHITECTURE

Copper was one of the first metals used by man and is one of our oldest building materials, with unique properties and characteristics. With the twentieth century and international modern movement came a transformation from copper's historic role as a durable roofing material to a flexible architectural skin over any surfaces including walls. The malleability of copper sheet allows it to be used as a covering for architectural elements of all shapes with minimal constraints. Surfaces can be flat, curved or faceted and used at any inclination or pitch, and in any environment. As a result, modern architects focused on copper as a comprehensive wrapping to express building form and maintain material continuity.

Architects continue to exploit this capability today, fired by the complex shapes made possible by computer aided design techniques. But, with the move to postmodernism and beyond, many designers have also been keen to explore new manifestations of copper – very much as part of the dynamics of contemporary architecture and with a real sense of freedom.

# Aurubis copper architecture

Aurubis is the largest producer of copper in Europe, with over 140 years experience, and is a world leader in copper recycling. The name Aurubis is based on the Latin for 'red gold' – reflecting the outstanding importance of copper since civilisation began. Aurubis Architectural is a division of the company resulting from the purchase in 2011 of Luvata Rolled Products, formerly Outokumpu – which started producing copper products for roofs, facades and other applications in 1940. Aurubis Architectural is committed to developing this long heritage in copper architecture and its Nordic brands, working in partnership with designers.

## REALISING DESIGNS IN COPPER

This book provides an introduction to the architectural opportunities and unrivalled freedom that architects can enjoy by working in partnership with us to realise their designs in copper, no matter how innovative. It explores how Aurubis Architectural redefines copper for contemporary design with the ongoing development of surfaces, forms and systems – not as a prescribed range of products to select from, but rather a source of inspiration for architects and the starting point for a creative partnership with us.

Our expertise and personal service are essential to developing your architectural visions in copper and we welcome an early involvement with your projects. Our website resource [www.aurubis.com](http://www.aurubis.com) will provide contacts, more detailed information and interactive tools to help you at each stage in the design and specification process.

## AURUBIS COPPER – CHARACTERISTICS

Aurubis' products for architectural applications such as facades and roofs use phosphorus deoxidised copper, designated Cu-DHP and complying with EN 1172:1997 – 'Copper and Copper Alloys: Sheet and Strip for Building Purposes'. This pure and natural material exhibits a unique range of characteristics and performance benefits including:

- » Protection by its patina against corrosion in any atmospheric conditions, durable and problem-free with no maintenance.
- » Exceptional, indefinite lifespan demonstrated over hundreds of years, and no underside corrosion issues.
- » Light weight as a flexible covering for any building elements, saving on structure and delivering low 'whole of life' costs.
- » Easily formed at any temperature without becoming brittle in cold weather.
- » Low thermal movement and high melting point avoiding stretching in hot weather.
- » Non-toxic and safe to work, with impressive antimicrobial qualities ideally suited to touch surfaces inside buildings.



The impressive sustainability and environmental credentials of copper have been clearly demonstrated in the past. Although the copper industry is well-known for recycling, Aurubis' Nordic range is exceptional with 97 % of copper produced for roofing and cladding applications over the last few years coming from recycled material. This material includes internal processing scrap (around 50–60 % of the recycled material). Embodied energy and global warming potential figures are therefore less than half those for copper generally – already significantly lower than stainless steel and aluminium.

## ARCHITECTURAL OPPORTUNITIES

Copper can provide a complete external skin, wrapping around complex building forms with material continuity. Alternatively, it can give distinctive character to individual facade or roofing elements, particularly when used in conjunction with other high quality materials. In addition, there is growing interest in the use of copper for interior design.

In addition to standard copper sheet, Aurubis explores new Forms of copper architecture with designers, including textured surfaces, profiled sheets and pressed surfaces. Also, perforated or expanded copper sheets and woven mesh add new possibilities for transparency. Installation techniques and Systems also help to define architectural character with texture and scale – ranging from traditional standing seam sheet installation techniques to panels, cassettes and other factory-made systems. Aurubis copper Forms and Systems are considered in more detail later.

But the natural colour changes leading to the development of copper's distinctive blue/green patina continues to fascinate architects and inform the development of Aurubis' Nordic Surfaces, discussed next.

The complex building form of the Svalbard Science Centre (Architects: Jarmund/Vignæs), designed as a direct response to the extreme wind and snow demands of its environmentally sensitive Arctic location, could only have been achieved in copper.



## COPPER SURFACES

The natural development of copper patina is one of copper's unique characteristics.

Within a few days of exposure to the atmosphere, the surface of Nordic Standard copper begins to oxidise, changing its colour from the 'bright' mill finish to a chestnut brown which gradually darkens over several years to a chocolate brown. Continued weathering can then result in development of the distinctive green patina – or blue in coastal locations. This process is an expression of the metal's propensity to revert to mineral compounds that resemble the ore from which it originally came. The patina film provides impressive protection against corrosion and can repair itself if damaged, defining the exceptional longevity of copper cladding.

Some rainwater is needed for the patina to form and its rate of development will depend on the water 'dwell time' on a surface. So, vertical cladding and sheltered surfaces will take much longer to patinate naturally than exposed roofs. Air borne pollution also increases the rate of patination, which therefore takes longer in more remote, cleaner environments than in cities or industrial areas. The complex combination of factors determines the nature and speed of development of patination, giving copper unique, living visual characteristics developing over time in response to local conditions.

Extensive copper facades, patinating naturally and just becoming green after 40 years, on the iconic 'Dipoli' building in Otaniemi, Finland.

Architects: Reima and Raili Pietilä





## NORDIC SURFACES

Over the last few decades, Aurubis has developed a range of factory applied surface treatments to provide straightaway the various stages of oxidation and patination. The processes involved are very similar to those taking place over time in the environment and utilise copper mineral compounds, not alien chemical treatments. Essentially, they bring forward the environmental changes without taking away the integrity of Aurubis copper as a natural, living material.

Aurubis' Nordic Surfaces include variable intensities of green or blue pre-patination and brown pre-oxidation. Copper alloys brass and Nordic Royal – a golden alloy – are also available, adding to a rich palette of colours and surface textures. All Nordic Surfaces form an integral part of the copper and are not coatings or paint. Ongoing changes will continue over time with all Nordic Surfaces depending on the local environment, ranging from quite rapid with Nordic Brass to minimal for Nordic Royal. Nordic Surfaces are supplied with a protective sheet to the finished face.

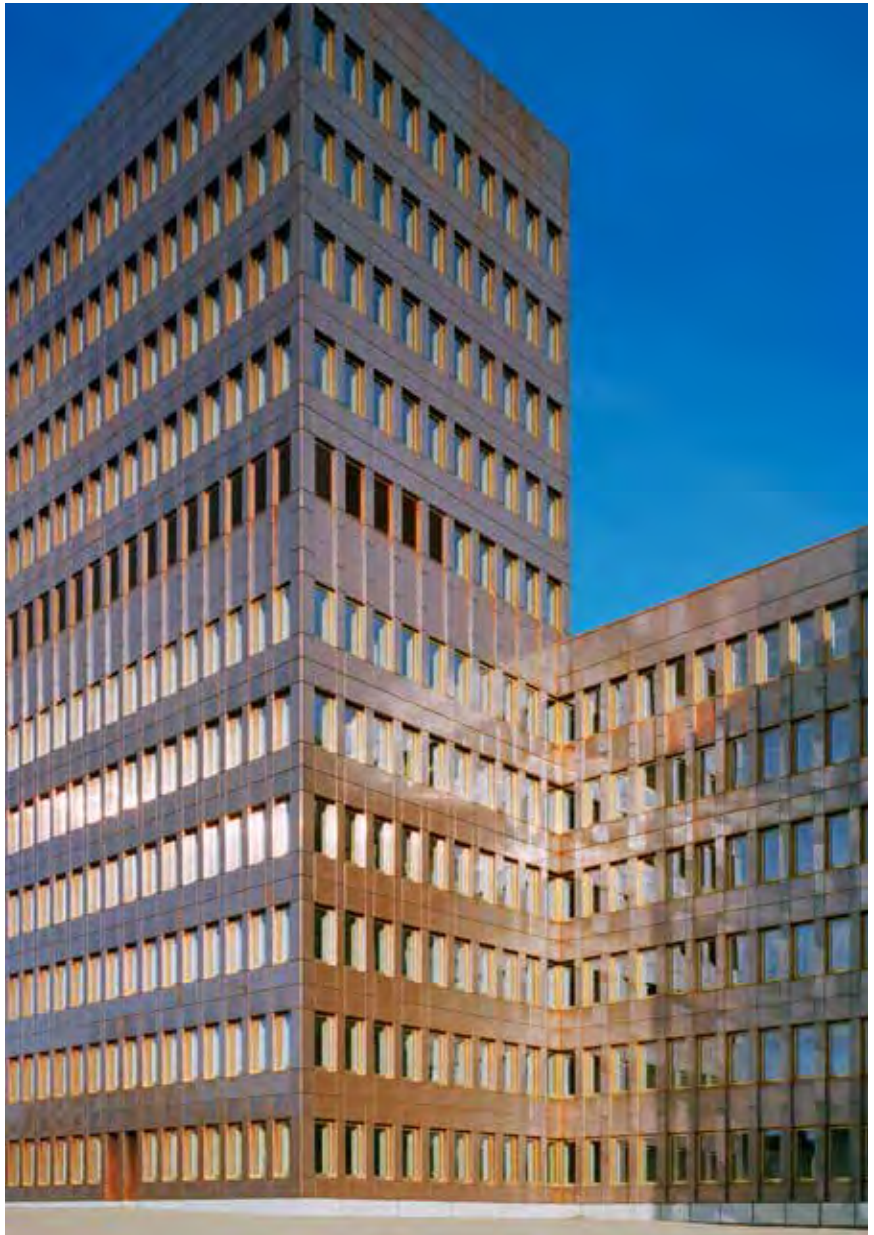
Aurubis' Nordic Surfaces are illustrated on the following pages. But Aurubis works closely with architects in developing bespoke surfaces and other techniques, in addition to the ranges shown here and our early involvement with the architectural design process is essential.





## Nordic Standard mill finish copper

Nordic Standard is mill finish copper without any additional surface treatments carried out in the factory. It has the traditional 'bright' finish that will develop and change in the environment, as described earlier.

Nordic Standard is available in sheets or coils.

- » Thickness range: 0.4–4.0 mm
- » Maximum width: 1,050 mm



Nordic  
Standard

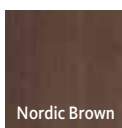
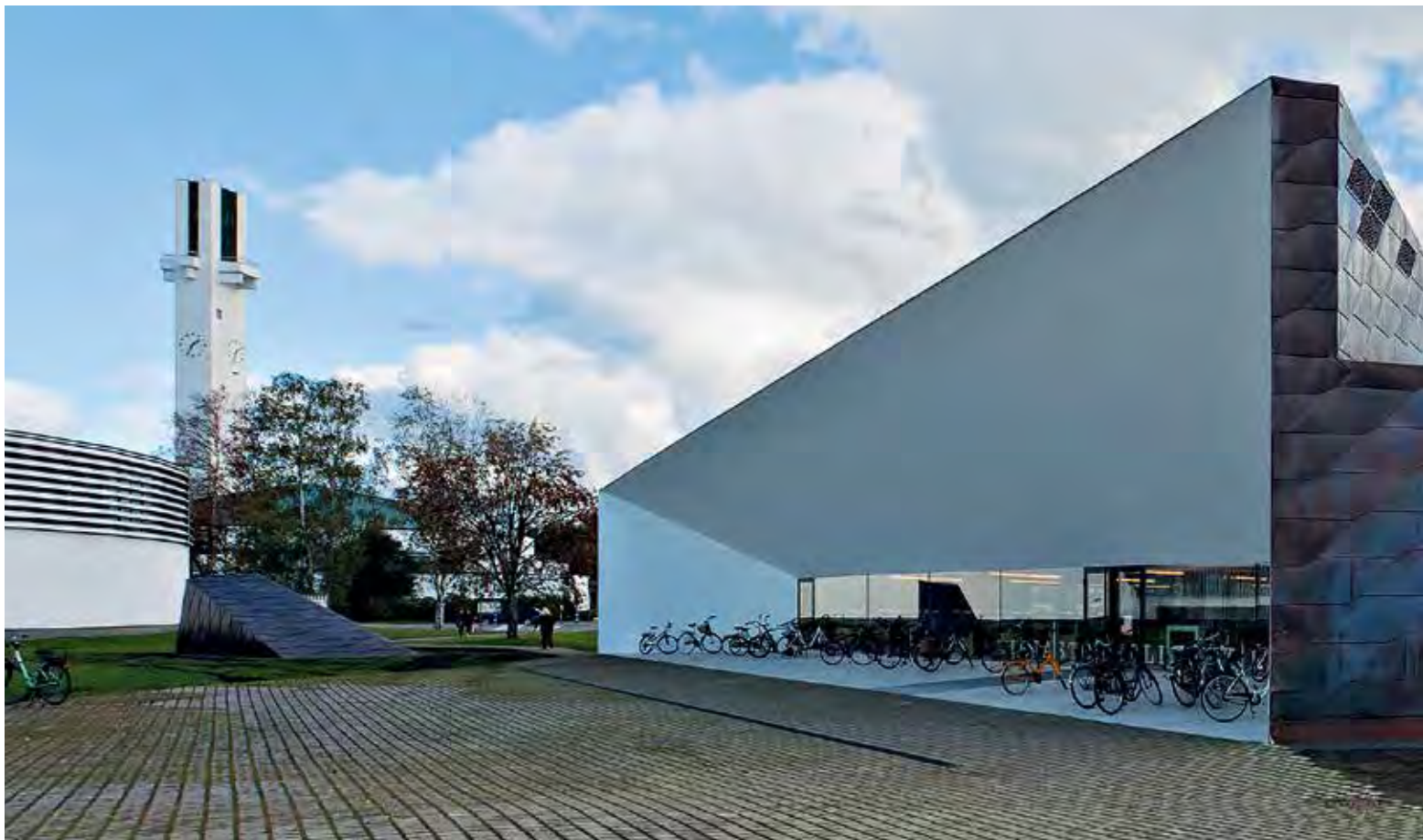

## Nordic Brown pre-oxidised copper

Nordic Brown products are pre-oxidised at Aurubis' factory to give straightaway the same oxidised brown surface that otherwise develops over time in the environment.

The thickness of the oxide layer determines the colour:

both Nordic Brown Light and the darker Nordic Brown versions are available.

Nordic Brown products are useful to minimise hand and other construction marks which can occur for a short time after installation with 'bright' standard copper. But light and dark versions can also be combined – perhaps with other finishes such as Nordic Standard – to create various visual effects.

Nordic Brown is available in sheets or coils.

- » Thickness range: 0.5–1.5 mm
- » Maximum width: 1,000 mm.







Nordic Green

## Nordic Green pre-patinated copper

Nordic Green products offer designers unparalleled design freedom and the ability to determine the type and intensity of green patina for each project with choices of 'Living' surfaces. In a carefully controlled, factory process, pre-oxidised copper is treated with specifically formulated copper compounds to create the desired patina colours and heat-treated to chemically bind them to the copper.



The factory process can be accurately controlled so that, as well as the solid green patina colour, other intensities of patina flecks can be created revealing some of the dark oxidised background material. Aurubis' experts can also work in partnership with architects to develop special individual levels of patination to meet their design requirements or to match historically patinated copper on existing buildings.

The material is easily bent and formed, and there are no limitations on the length of pre-patinated copper sheet or strip because whole coils are treated on the production line, not just limited size sheets. Nordic Green is available in sheets or coils with one surface treated.



- » Thickness range: 0.5–1.5 mm
- » Maximum width: 1,000 mm



## MINERAL BASED GREEN

The most common compound found in natural patinas all over the world is the copper sulphate mineral brochantite. Aurubis' factory-applied patinas have been developed with properties and colours based on the same brochantite mineralogy. Brochantite is a light blue colour but in many locations impurities and other components in the air add a yellow tint to give the naturally developed patina a green hue. In the same way, Nordic Green is produced with a hint of iron sulphate yellow component added to the blue copper sulphate, replicating the natural green.

By its nature, Aurubis' pre-patination process encourages the continuing formation of natural patina by releasing copper sulphate to react with the copper below. So, just like natural patina, Nordic Green undergoes continuous changes through environmental exposure dependant upon local atmospheric and rainfall condition.





Nordic Blue

## Nordic Blue pre-patinated copper

Nordic Blue products offer designers unparalleled design freedom and the ability to determine the type and intensity of blue patina for each project with choices of 'Living' surfaces. In a carefully controlled, factory process, pre-oxidised copper is treated with specifically formulated copper compounds to create the desired patina colours and heat-treated to chemically bind them to the copper.

The factory process can be accurately controlled so that, as well as the solid blue patina colour, other intensities of patina flecks can be created revealing some of the dark oxidised background material. Aurubis' experts can also work in partnership with architects to develop special individual levels of patination to meet their design requirements or to match historically patinated copper on existing buildings.

The material is easily bent and formed, and there are no limitations on the length of pre-patinated copper sheet or strip because whole coils are treated on the production line, not just limited size sheets.

Nordic Blue is available in sheets or coils with one surface treated.

- » Thickness range: 0.5–1.5 mm
- » Maximum width: 1,000 mm



## MINERAL BASED BLUE

The most common compound found in natural patinas all over the world is the copper sulphate mineral brochantite. Aurubis' factory-applied patinas have been developed with properties and colours based on the same brochantite mineralogy.

In marine climates, the natural copper patina contains some copper chloride giving it more of a blue colour and this is emulated with Nordic Blue. Brochantite is a light blue colour and Aurubis' Nordic Blue patination is 100 % brochantite.

By its nature, Aurubis' pre-patination process encourages the continuing formation of natural patina by releasing copper sulphate to react with the copper below. So, just like natural patina, Nordic Blue undergoes continuous changes through environmental exposure dependant upon local atmospheric and rainfall condition.





Nordic Royal

## Nordic Royal copper alloy

Nordic Royal is an alloy of copper with aluminium and zinc, giving it a rich golden through-colour and making it very stable. It has a thin protective oxide layer containing all three alloy elements when produced. As a result, the surface retains its golden colour and simply loses some of its sheen as the oxide layer thickens with exposure to the atmosphere to give a matt finish. It behaves differently to other Aurubis copper products over time and does not develop a blue or green patina.

Nordic Royal alloy is available in sheets or coils.

- » Thickness range: 0.5–1.5 mm
- » Maximum width: 1,000 mm

Nordic Green is available in sheets or coils with one surface treated.

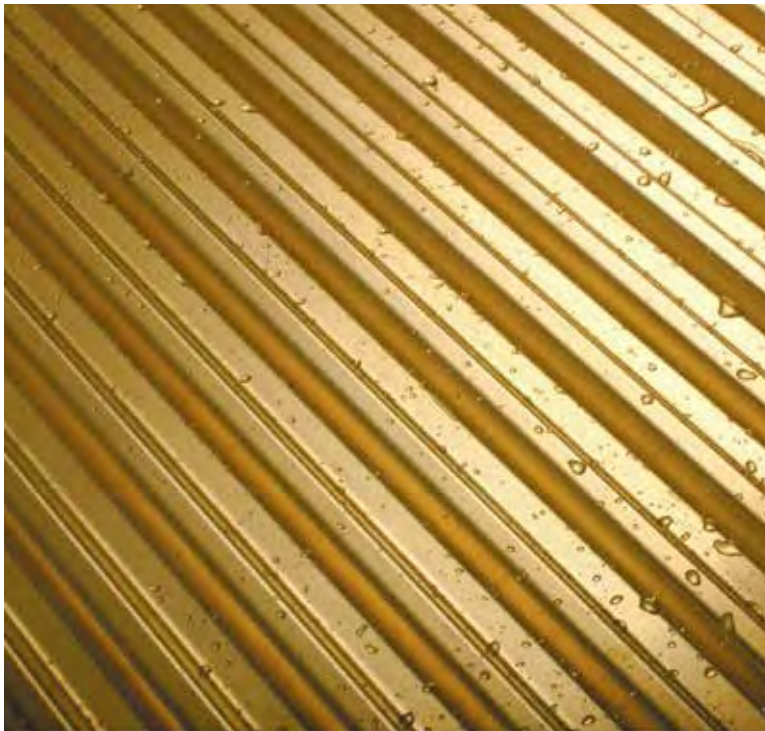
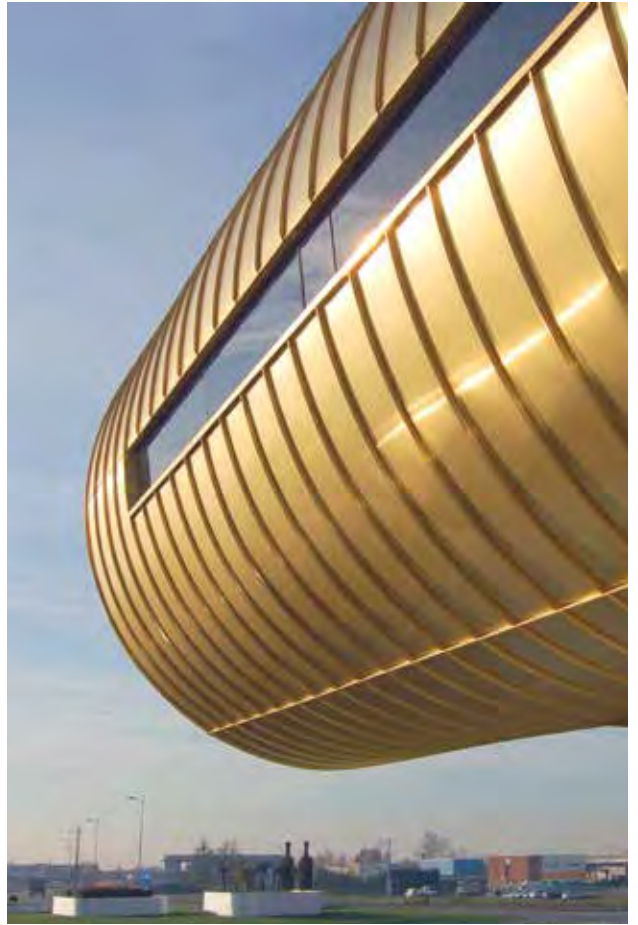

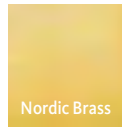

## Nordic Brass copper alloy

Nordic Brass is an alloy of copper and zinc with a distinctive golden yellow colour. When exposed to the atmosphere, the surface begins to darken within weeks and can change to a dark brown in around a year – unlike Nordic Royal alloy which retains its original colour.

Nordic Brass is available in sheets or coils.

- » Thickness range: 0.6–2 mm
- » Maximum width: 1,000 mm.



## Nordic Bronze copper alloy

Nordic Bronze is an alloy of copper and tin with a similar colour to Nordic Standard initially. When exposed to the atmosphere, the surface gradually changes to a stable, dark chocolate brown. This process is slower than with Nordic Brass.

Nordic Bronze is available in sheets or coils.

- » Thickness range: 0.5–2.0 mm
- » Maximum width: 780 mm

It can also be provided in a wide range of different forms and used in various systems.

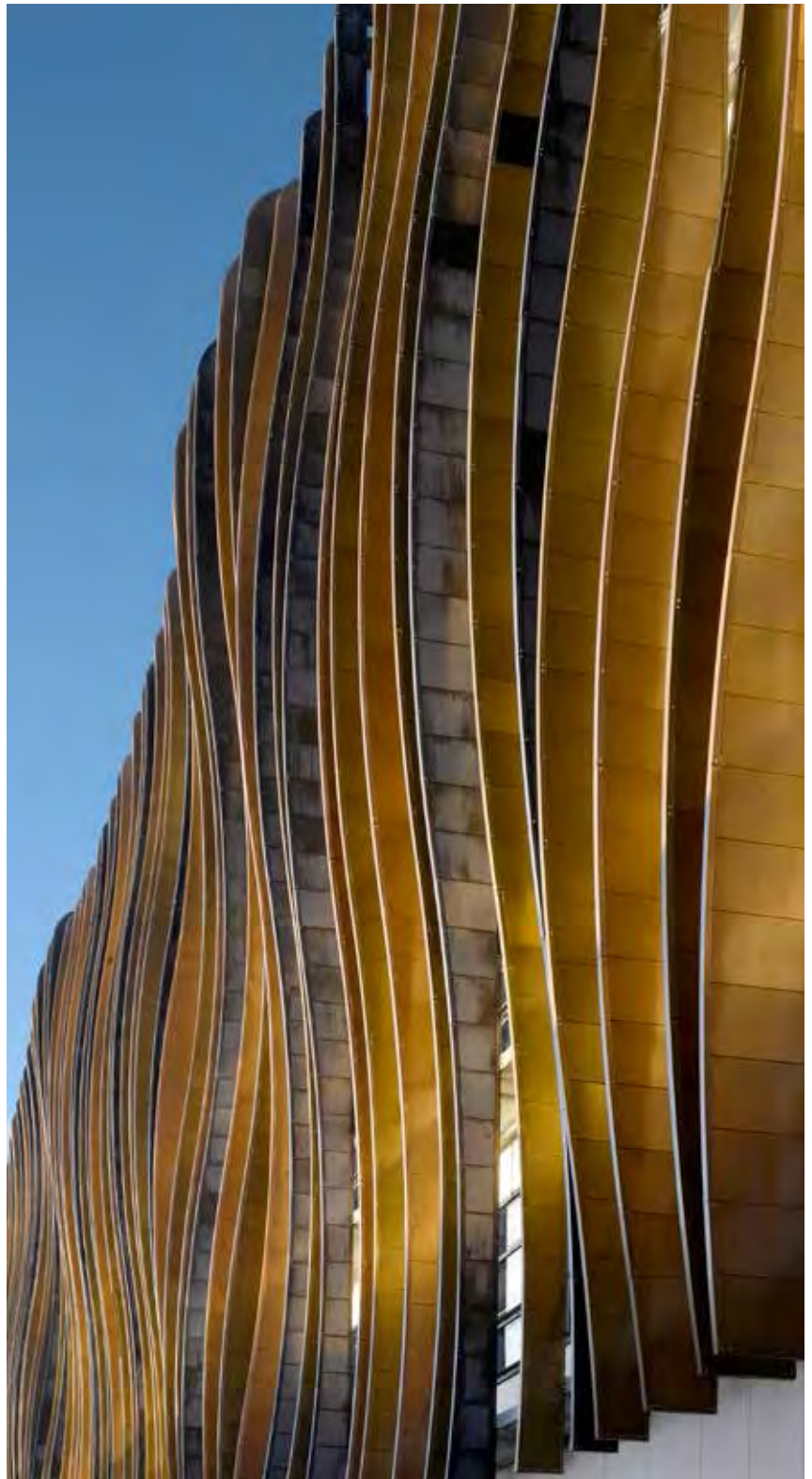

Vertical solar shading fins, each clad in either Nordic Bronze, Nordic Brass or Nordic Brown.  
Holland Park School, London; Architects: Aedas.





## Nordic forms

Apart from standard copper sheet, Aurubis is constantly exploring new forms of copper with designers, creating extra dimensions of modulation, texture and transparency for architectural surfaces.

Nordic forms include:

- » Nordic Decor textured surface
- » Profiled sheets
- » Pressed surfaces
- » Perforated and expanded sheets
- » Woven mesh

Most of these products are supplied by Aurubis and others are developed in a close working relationship with our specialist partners. In many cases, these products can be supplied with choices from Aurubis' Nordic Surfaces as well.



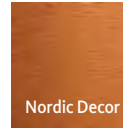

## Nordic Decor textured surface

Nordic Decor provides a rustic, grainy surface texture embossed onto one face of copper sheets or coils. As well as providing visual interest closeup, it disguises hand marks and other blemishes, particularly when used internally (where oxidation and patination may not occur).

Nordic Decor is available in sheets or coils.

- » Thickness range: 0.6–1.0 mm
- » Maximum width: 1,000 mm.

Nordic Decor is available in the full range of Nordic Surfaces.



## Profiled sheets

Aurubis offers an extensive choice of roll-formed or welded profiled sheets in the full range of Nordic Surfaces: full technical details are available on the website. Other, bespoke profiles can also be provided to order.

# Perforated, expanded and woven mesh

Aurubis offers a range of standard perforation patterns onto its copper sheet with any Nordic Surface, as well as special, bespoke patterns. Variable perforation sizes can be used to create subtle patterns, 'super graphics' and even text. Our partners can also provide expanded copper sheet with any Nordic Surface or woven copper wire mesh to suit particular requirements.

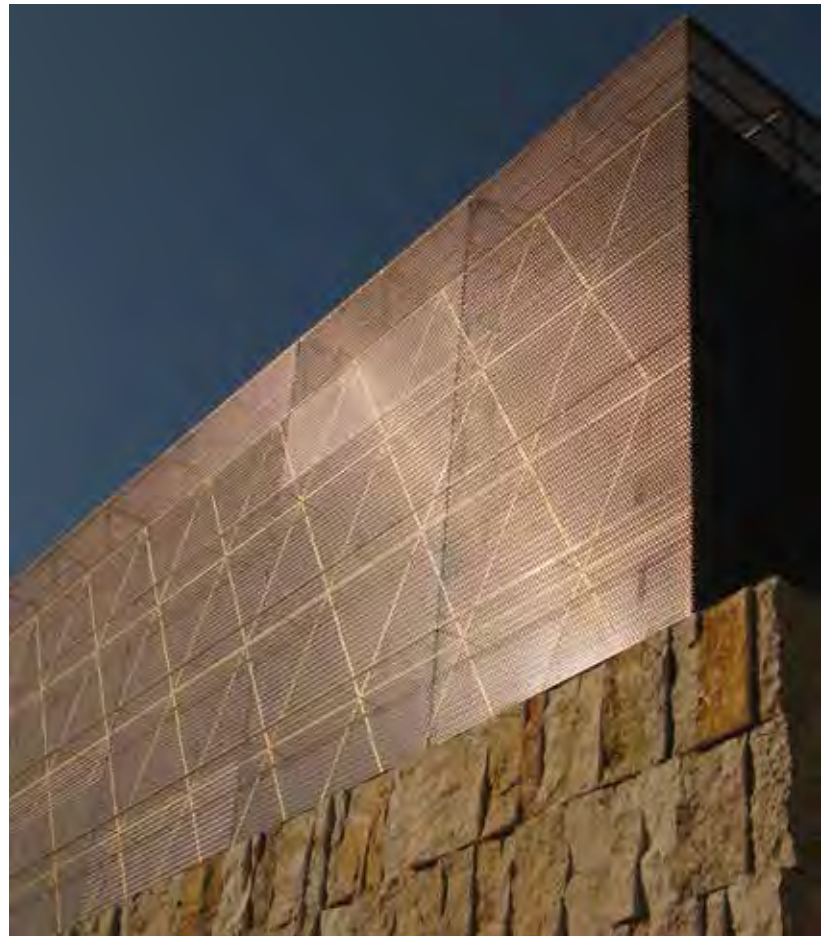



## Transparency with copper

Perforated and expanded copper sheet, and woven copper wire mesh add an extra dimension of transparency. For example, the Sven Harry Karlsson Museum in Stockholm, uses perforated Nordic Royal for ceilings, soffits and cladding, as well as mesh to divide balcony areas.

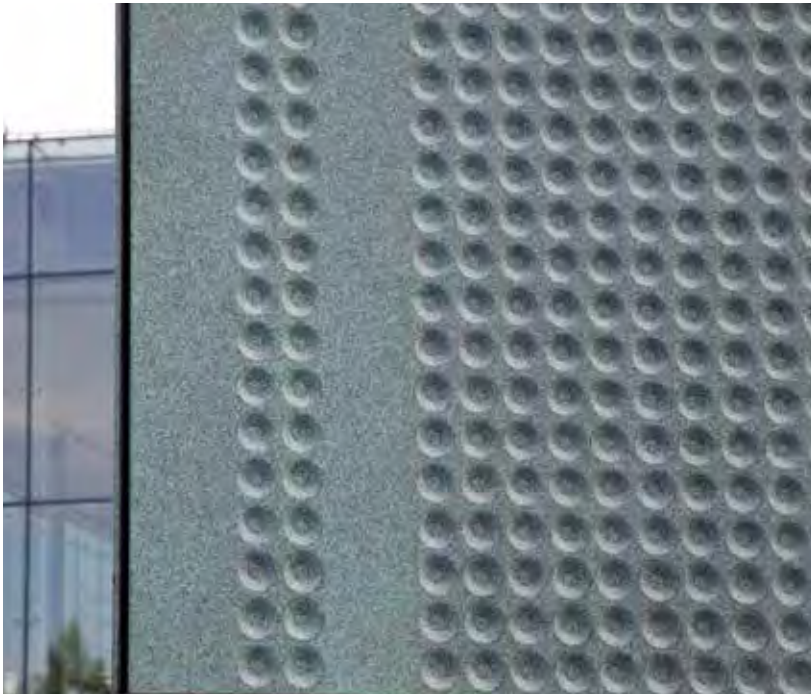

## Pressed surfaces

Our partners can press mould Aurubis copper sheet which has any Nordic Surface – including perforated and expanded forms – using advanced techniques to suit bespoke designs.



# Nordic Systems

We have seen how an unrivalled choice of Nordic Surfaces can be combined with different Nordic Forms to provide a rich copper palette for contemporary architecture. The final ingredient in designing with copper is the installation technique or system, which will add 'grain' and structure to the external skin of the building helping to define its character. Aurubis provides an extensive range of factory pre-fabricated Systems for facades or roofs, as well as copper sheets or coils and other copper items.



Large areas of Long Strip roofing, created with Nordic Green pre-patinated copper, are used throughout the Tsaritsyno Palace in Moscow.

# Traditional techniques

Traditionally, copper has been used as a lightweight, fully supported covering to roofs, walls and other building elements. Here, sheets of copper are jointed using double lock standing seams (or angle seams for vertical cladding) visually defining the copper bays, interrupted by cross-welt joints running longitudinally.

A more modern interpretation of fully-supported, standing seam technology is Long Strip. In this case, copper trays are prefabricated with profiles and installed in long lengths – perhaps 10 m or more – eliminating cross-welts and creating a strong linear appearance. Long Strip is an efficient and cost-effective method where mechanisation can be maximised both for prefabrication and jointing on site. Aurubis copper can be supplied in cut-to-size sheets or in coils to suit any system.

In particular, Aurubis is unique in its ability to supply any of its Nordic Surfaces in coils for Long Strip.





## Prefabricated systems

Apart from traditional systems, various standard or bespoke prefabricated systems are available in Aurubis copper. They offer the benefits of consistency and accuracy, being fabricated under controlled off-site



### **PREFABRICATED TRAYS**

The RPPE 105 prefabricated tray is a fully-supported 0.5–0.6 mm thick copper tray, pre-formed ready for fast, efficient installation.

Width: 475 mm, maximum length: 8 m

### **SHINGLES**

Fully supported copper elements for facades or roofs, shingles offer a distinctive 'fish scale' appearance with shapes including squares, diamonds, rhomboids and rectangles (as shown opposite), in various sizes. The RMOD 402 shown below is 280 x 280 mm using 0.6 mm copper.



conditions, as well as different visual characteristics helping to define the architecture.

Aurubis fabricates four ranges, each with various systems, providing a wide choice of visual scale and detail.

Just a few examples are shown here and full technical information is available in the Designers Tools sections of each range on the website [www.aurubis.com](http://www.aurubis.com).



## PANELS

For facades, self-supporting copper panels pre-formed on two sides can be used vertically, horizontally or diagonally to give a linear, striated appearance. Various shapes and sizes are available. The example shown here is FPAN 101 using 1.0–1.2 mm thick copper. Height: 200–300 mm, maximum length: 3 m



## CASSETTES

For larger flat areas, cassettes have squarer proportions with folded edges to all four sides. Various types and sizes are available. The example shown below is FCAS 101 using 1.0–1.5 mm thick copper. Height: 450–900 mm, Length: 450 mm–3 m







Plaza, Helsinki, Finland

# Standards Dimensions



## IDENTIFICATION AND TRACEABILITY OF THE PRODUCT:

Cast cakes coming from the foundry are marked with different colours and with our own Aurubis alloy markings. These markings are found in Notes database Aurubis Alloy Catalogue. In addition to the alloy code there is a barcode sticker on the cakes with following data:

- » casting number
- » dimensions of the cake
- » code of the cake
- » alloy
- » weight

In the sticker there is also a barcode, where all above mentioned data is found.



## Environmental management system

The environmental Management system applied in Aurubis is certified by ISO 14001: 2004

## Quality Management System

Quality management system applied in Aurubis is certified by ISO 9001 : 2008

## Safety management system

Safety management system applied in Aurubis is OHSAS 18001 : 2007

## IDENTIFICATION OF THE PRODUCT IN MANUFACTURING

At every stage of operation, after each operation stage a sticker is printed out and attached on the product with following data:

- » working number and item code
- » alloy
- » thickness in millimetres
- » width in millimetres
- » coil number
- » next operation stage

Traceability of products in the production is arranged as follows:

Casting number of each cake is replaced by coil number before hot rolling. This replacement is done by the rolling mill shop floor control system.

This coil number follows the product (coil or sheet) throughout the whole process. This control system enables the inspection or following of all process stages afterwards.

## MATERIAL PROPERTIES

In accordance with DIN EN 1172 (Metal Sheets and Strips in Building Work), only copper designated Cu-DHP, an oxygen-free, phosphor-deoxidised copper with a degree of purity of 99.9 % or CuZn 0.5, a material with a slight zinc additive may be used in building work. These kinds of copper are easy to shape, have a high breaking elongation and are suitable for welding and hard and soft soldering.

The tables below shows values relating to the temper and dimensions for copper sheeting and strips designed for construction purpose in accordance with EN 1172 (European standard covering sheet metals and strips for construction purpose).

## GENERAL

Sheets and strip can be divided into five different thickness groups which differ from each other with reference to properties.

- a) Thickness area 0.4–1.50 mm, <0.4 mm only in hard temper
- b) 1.51–5.00 mm, c) 5.01–9.00 mm
- d) 9.01–25.00 mm, e) 25.01–100.00 mm

## SURFACE CONDITIONS FOR AURUBIS ROLLED PRODUCTS

The surface finish (roughness) is achieved in the final cold rolling stage.

The roughness of the rolls and the oil used (or emulsion) are of big importance. By treating the material after the final cold rolling we can achieve special features (wett surface, dry surface, brushed surface etc).

MECHANICAL PROPERTIES										EN 1172
Designation			Tensile strength		0,2 % proof strength		Elongation	Hardness		Trade designation
Material		Material condition	R <sub>m</sub> N/mm <sup>2</sup>		R <sub>p0,2</sub> N/mm <sup>2</sup>		A <sub>50 mm</sub> %	HV		
Symbol	Number		min.	max.	min.	max.	min.	min.	max.	
Cu-DHP CuZn0.5	CW024A CW119C	R220	220	260	–	140	33	–	–	annealed
		H040	–	–	–	–	–	40	65	annealed
		R240	240	300	140	–	8	–	–	semi-hard
		H065	–	–	–	–	–	65	95	semi-hard
		R290	290	–	250	–	–	–	–	full-hardness
		H090	–	–	–	–	–	90	–	full-hardness
CuSn 0.15	CW117C	R250	250	320	200	–	9	–	–	
		H060	–	–	–	–	–	60	90	
		R300	300	370	250	–	4	–	–	
		H085	–	–	–	–	–	85	110	
CuAl5Zn5Sn1	CW309G	R400	400	–	170	–	45	–	–	
		H080	–	–	–	–	–	80	–	
CuSn4	CW450K	R290	290	390	–	190	40	–	–	
		H070	–	–	–	–	–	70	100	
CuZn15	CW502L	R310	310	370	200	290	10	–	–	
		H090	–	–	–	–	–	90	115	

DIMENSIONS, TOLERANCES AND MASS PER UNIT LENGTH							EN 1172
Nominal dimensions, mm				Tolerances, mm			Mass per unit length <sup>1)</sup> at 100 mm width
thickness	width	preferred length of sheet	coil inside diameter for strip	thickness	width	length of sheet	approximate
0.5	up to and including 1,250	2,000 or 3,000	300, 400, 500 or 600	± 0.02	+2 0	+10 0	0.445
0.6							0.534
0.7							0.623
0.8							0.712
1							0.890

<sup>1)</sup> Calculated with a density of 8.9 g/cm<sup>3</sup>

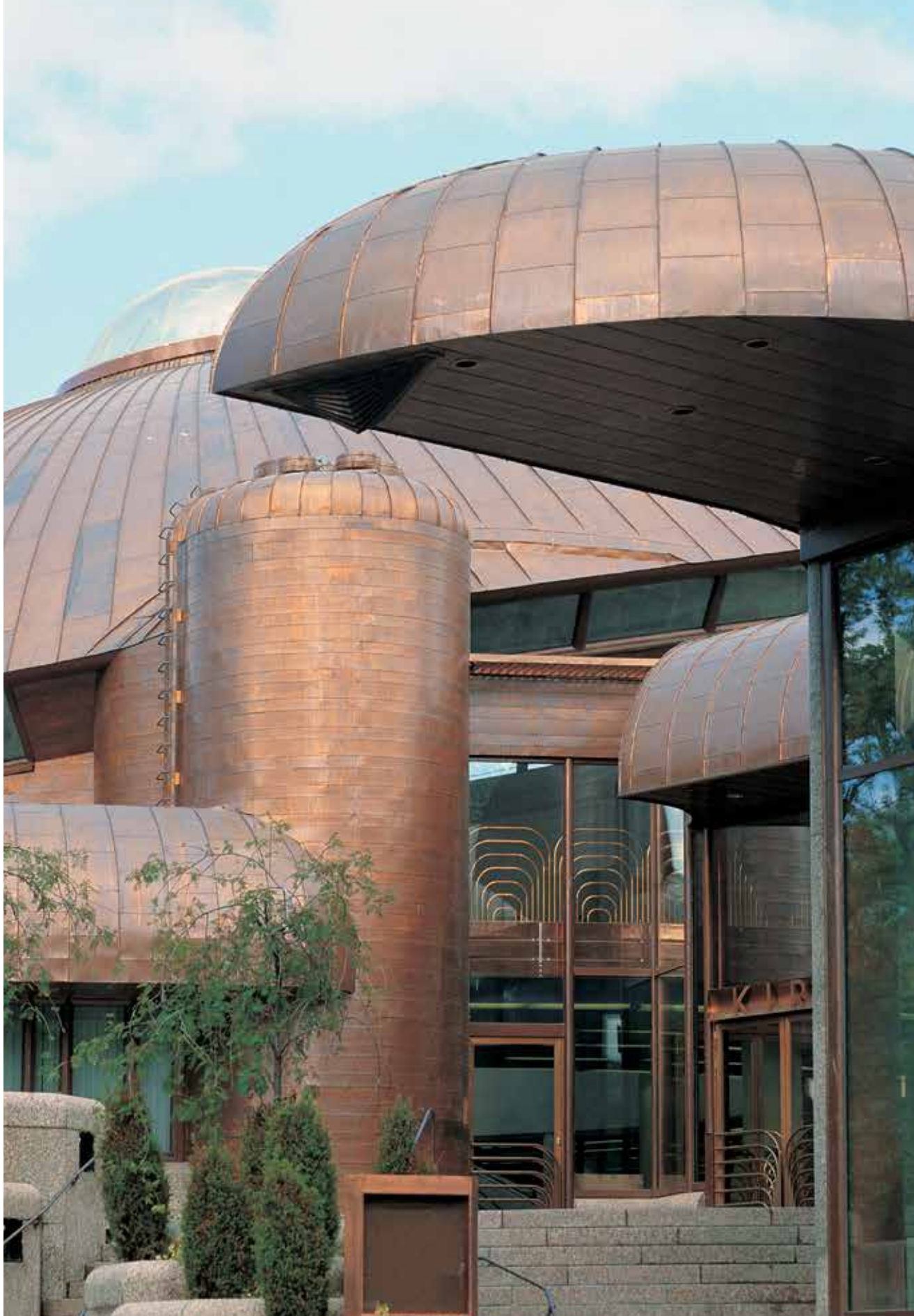

Library, Tampere, Finland

# Technology

# The climatic shell of the building

## EXTERNAL EFFECTS

### Rain

Roofs and exterior walls are exposed to great stresses when it rains. Unsealed points in the weathering allow rainwater to penetrate easily into the roof structure/walls and down into underlying areas. The eaves, ridges, flashings and connections to higher walls are particularly susceptible areas, as – of course – are all holed areas or overhangs.

Rain is at its most hostile in combination with strong winds and when it drives obliquely towards the building. In strong winds, rain can be driven up along the outer roof – even in the case of roofs with a substantial angle – and find its way into the roof cavity through joints and details.

When the wind speed is in excess of the rate at which the drops of rain are falling, vertical surfaces may come into contact with more rain than horizontal surfaces. Thus the total amount of driving rain to affect the material is dependent on both the amount of precipitation and the wind speed. The greatest amounts of driving rain hits the eaves and corners of the roof. Gable facades are also more exposed to rain than long facades. A long roof overhang can provide effective protection for the underlying facades.

Skilled design of roofs and exterior walls is required due to the material stresses caused by hard driving rain. If the roof is to provide effective protection against rain, it is important for the roof drainage system, including gutters and piping, to be designed and dimensioned correctly and for the gulleys and overflows to be positioned correctly. Misplaced gulleys in the case of shallow angled roofs are a common cause of standing water.

In the case of internal roof drainage, it is important to set up overflows at points where there is a risk of blockages in the downpipes. It should be possible for

the overflows to be able to cope with three times the estimated flow of water.

At points where the roof is connected to a higher exterior wall, it is necessary to allow for the total quantity of water which can collect here and thus stress the roof in the event of driving rain.

### Snow

Snow on the roof can result in major stresses on the roof structure. Because snow is hygroscopic (that is to say, it absorbs moisture), its density when a thaw sets in is almost the same as that of water. Areas of snow can lead to load concentrations which have to be taken into consideration when designing the load bearing structure.

The volumes of snow that can conceivably stress roofs do, of course, depend on the location of the building (both geographically and locally), but the roofing material (the friction) and the design of the roof are also central to this. It has been proven that roofs with a slope of 20–30° do generally collect more snow on them than is the case with roofs with more substantial slopes or roofs with shallower slopes.

It is quite easy to understand why snow does not settle as readily on a steep roof as it does on a flat one. But even roofs which are flatter than 20–30° generally collect less snow than roofs at an angle of 20–30°. The reason for this is that in the case of roofs with a shallow slope, the covering of snow is reduced even when the wind blows very gently (of course, counteracting factors include sharp ridges, structures or other specific sections where pockets of snow can readily form). On the other hand, in the case of steeply sloping roofs there is often a leeward side where the snow can settle and increase in volume. This means that when roofs are designed, both variable and fixed loads have to be taken into account.

Snow flakes fall less quickly than raindrops, so they can remain suspended in the air for longer and be driven upwards and downwards by currents of air. In this way, fresh snow can penetrate into the building through what appear to be well protected holes, vents, slots and unsealed points.

When the snow melts, it can start to slide and damage cowlings, pipe flashings, guttering, etc. Snow guards and devices for preventing snow from sliding can prevent this, as well as stopping snow from falling down from the roof. The mountings of such snow obstruction devices are subject to great stresses and must be designed accordingly.

### Ice on the roof

Ice and icicles can form on both steep and shallow roofs. When the snow melts and the weather changes, ice is generally formed from standing water. Pieces of ice which are subject to a gradual reduction in temperature crack easily due to the high coefficient of thermal expansion of the ice. If the ice is frozen onto the weatherproofing layer, the movements of the cracks can lead to the material being torn – although this is impossible if metal roof coverings are used.

### Icicles on the eaves

When snow melts, it is common for icicles to form on the eaves which can cause dampness in both the eaves and the underlying facade along their length. Blocks of ice can form in gutters and downpipes which lead to stopping the flow of water from the roof.

If ice forms in gutters and downpipes, it is possible to use a heating cable to melt it. However, it is important to clarify why the ice formed before implementing any kind of measures to counteract it.

Icicles due to the dispersion of heat from inside form initially when the covering of snow on the roof has become so thick that it provides an insulating layer. The melting point is then transferred to the snow, which slowly begins to melt. The causes of such leakage of heat include poor insulation, insufficient ventilation or, quite simply, unsealed points which allow warm air to leak out of the building.

Roof drainage systems, the thermal insulation of the eaves and the roof and the ventilation systems must be carefully installed in order to prevent all kinds of ice formation.

### Recommendation for roof drainage

- » steep, cold roofs can have external cold drains
- » warm roofs, roof terraces and the like must have warm drains
- » flat roofs – both warm and cold – should have warm drains

However, it is not always all that simple to define a precise boundary between roofs which can be considered “cold” and those which can be deemed “warm”. Precise calculations are required in each individual case in order to be able to assess, in a pertinent manner, what the best solution is in respect of moisture.



Icicles on the eaves indicate that heat is leaking out.



The formation of ice on the eaves can be prevented to some extent by using a heating cable, but it is important to design the roof initially in such a way as to prevent the formation of ice.



## Hail

Purely hypothetically, violent hailstorms can, of course, lead to damage to the copper sheeting. However, in general hail has never led to serious problems. Moreover, it is equally impossible to attempt to predict or estimate the extent of this risk or take it into account when selecting materials and designing roofs or facades.

## Wind

Wind loads are the strongest, most frequent hostile factors which affect roofs and facades. A closely reasoned knowledge of wind loads is required in order to be able to assess correctly which dimensions to use for the attachment of roof coverings and facade cladding.

Wind blowing against a building causes positive pressure on the windward side and negative pressure on the other sides of the building. If the wind blows directly onto the building, the strongest positive pressure occurs towards the centre of the windward side and diminishes towards the corners. On the leeward side, the greatest negative pressure occurs at the corners and upper section of the facade. The distribution of pressure is also affected by the direction of the wind, the turbulence, the geometrical design of the building and the topography of the surrounding area.

## Lightning

There is no additional risk of lightning strike if roof coverings and wall claddings are made of metal as opposed to any other material. Quite the opposite is true: the ability of the metal to conduct electricity is used in lightning protection systems for buildings. There are clear regulations and instructions available on how metal is to be used in roofing and for down conductor systems.

Lightning strikes can cause burns to the metal. If a lightning discharge strikes a metal conductor, the exchange of heat can be sufficiently great to melt the metal. In the case of thin metal sheeting, burn holes may form at the site of the strike.

Profiled copper can be used as a roof conductor and lightning protection system. Profiled copper on walls can correspondingly act as a down conductor. The recommended distance between the roof and the ground

– where the down conductor is connected to the earth conductor – should not exceed 20 m, and the thickness of the sheeting should be no less than 0.6 mm.

Facade sheeting can also be used as a lightning protection system and roof conductor system. The seams act as protectors, and experience has shown that there is very little spark emission in the seams.

## Temperature

Roofs and facades are subject to great temperature variations, which in turn give rise to stresses and movements in the material. Primarily the roof, but also the facade, has to be designed with a view to the fact that temperature variations may occur between the external surface and the underlying structures. Factors which affect the material include the air temperature, intensity of solar incident radiation, wind speed, thermal capacity and thermal resistance in the material, as well as the ability of the surface to absorb and dissipate heat.

## Pollution

Substances – primarily pollutants – in the air and water (precipitation) affect roofing and facade materials in different ways. Metals can be broken down, corrode or otherwise be dissolved and leached away by sulphur dioxide, chlorides and sulphates, for example.

Guano, a mixture of moisture-collecting dirt and algae can cause damage to the metal. Divisions into corrosivity classes are used to classify the effects of various climatic factors, including the frequency of the occurrence of corrosion. The classes for atmospheric corrosivity are designated C1, C2, C3, C4, C5-I and C5-M. The additional letter I in class C5 stands for “industrial environment”, and the letter M stands for “marine environment”. The following table also shows examples of environments which are considered typical for each respective corrosivity class.

In general, classes C2 – C5 are the most relevant for roof coverings and wall claddings.

It is worth noting that division into corrosivity classes is carried out primarily to assess the need for corrosion protection on steel structures; but these divisions are also used as a foundation for the selection of corrosion protection for sheet metal.

**CORROSIVITY CLASSES IN ACCORDANCE WITH SS-EN ISO 12944-2**

Corrosivity class	Corrosivity of the environment	Examples of typical environments in the temperate climatic zones (for information)	
		Outdoor	Indoor
C1	Very low		Heated areas with dry air and insignificant quantities of pollution, e.g. offices, shops, schools and hotels.
C2	Low	Atmosphere containing low atmospheric pollution. Rural areas.	Non-heated areas with variable temperature and humidity. Low frequency of condensation and low atmospheric pollution, e.g. sports centres, storage areas, etc.
C3	Moderate	Atmosphere containing a certain quantity of salt or moderate atmospheric pollution. Urban areas and slightly industrialised areas, as well as areas with a certain amount of influence from marine atmosphere.	Areas with moderate humidity and a certain quantity of atmospheric pollution from production processes such as breweries, dairies, dry cleaners, etc.
C4	High	Atmosphere containing moderate quantities of salt or appreciable atmospheric pollution. Industrial or coastal areas.	Areas with high humidity and large quantities of atmospheric pollution from production processes, e.g. the chemical industry, swimming pools and shipyards.
C5-I	Very high (industrial)	Industrial areas with high atmospheric humidity and an aggressive atmosphere.	Areas with almost permanent condensation and large quantities of atmospheric pollution.
C5-M	Very high (marine)	Coastal and offshore areas with large quantities of salt.	Areas with almost permanent condensation and large quantities of atmospheric pollution.



The best way to prevent damage as a consequence of accessing and working on the roof is to construct fixed walk ways.

## Reverse diffusion

Reverse vapour transfer in exterior walls is a problem which has been noted in the outer leaves of cavity walls which have been temporarily subjected to hard driving rain and then been warmed rapidly by heat from the sun. The result of this is the collection of moisture on the outside of the vapour barrier which can lead to damage due to dampness and mould in the exterior wall.

A similar phenomenon occurs in the roofs above ice rinks which are in use during the summer. Inside the rink and up at the roof of the rink, the temperature variations result in the formation of condensation, which precipitate on the vapour air seal in different ways depending on the type of roof, insulation and detail design.

## Clearing from snow

Copper roofs should ideally be cleared of snow using a wooden snow shovel in order to avoid causing damage to the copper sheeting. The best way to prevent damage as a consequence of accessing and working on the roof is to construct fixed walkways when the roof is being built.

## Damage and destruction

There must be a rigid, wall-to-wall underlay behind the sheeting in order to prevent the sheet metal cladding from being dented or damaged.

As regards facades in exposed positions, it is possible to make the lower section more stable by using a base which is better able to withstand external influences rather than the facade itself.

## INTERNAL EFFECTS

Both roofs and exterior walls can be subject to dampness starting from inside the building. Moisture in the indoor air strives to become equal with the moisture in the outdoor air. This equalisation can take place by means of either diffusion or convection. Diffusion is caused by the difference between the vapour concentration outdoors and the vapour concentration indoors. Convection is caused by differences in air pressure and temperature.

### Diffusion

Indoor atmospheric humidity takes the form of vapour which is produced by indoor activities (such as washing or showering) and people (breathing). Differences in vapour concentration in different parts of the building are crucial to the direction of vapour transfer. Vapour transfer takes place from a higher vapour concentration to a lower vapour concentration.

Vapour concentration, designated  $v$  ( $\text{g}/\text{m}^3$ ) is a measure of the amount of water vapour in the air. This also applies to air in the pores of various materials.



Factors which affect the material include the air temperature, intensity of solar incident radiation, windspeed, thermal capacity and thermal resistance in the watering.

The greatest quantity of water vapour which the air is able to contain at a specific temperature is known as the saturation vapour concentration and is designated  $v_s$  ( $\text{g}/\text{m}^3$ ).

SATURATION VAPOUR CONCENTRATION AT VARIOUS TEMPERATURES	
Temperature ( $^{\circ}\text{C}$ )	Saturation vapour concentration ( $\text{g}/\text{m}^3$ )
-20	0.89
-16	1.27
-12	1.80
- 8	2.53
- 4	3.52
0	4.86
4	6.36
8	8.28
12	10.67
16	13.63
20	17.28
22	19.41

Saturation vapour concentration,  $\text{g}/\text{m}^3$

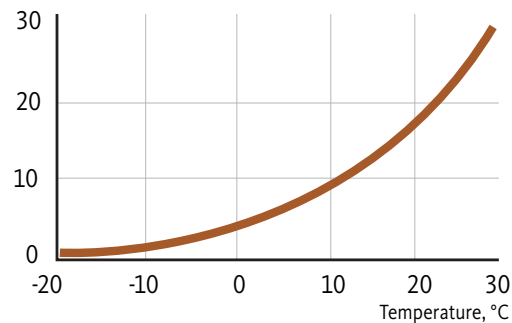

Figure:  
Link between saturation vapour concentration and temperature.

The relative humidity (RH) is used as an expression of the current air water content. The RH is the ratio of the vapour concentration ( $v$ ) to the saturation vapour concentration ( $v_s$ ) at the specific temperature.

The risk of dampness occurring on account of condensation can be assessed on the basis of the RH and the temperature.

Condensation forms when the vapour concentration is equal to or in excess of the saturation vapour concentration at the specific temperature.

### Example

The RH is 65 % and the temperature is 20 °C.

- » how much water vapour is in the air?
- » at what temperature is there a risk of condensation forming?

From the table (page 77), we can see that:

$$v_s = 17.28 \text{ g/m}^3$$

$$\text{RH} = \frac{v}{v_s} \rightarrow v = \frac{65 \times 17.28}{100} = 11.23 \text{ g/m}^3$$

Using the collection of statistical tables for saturation vapour concentration, we can demonstrate that there is a risk of condensation forming at temperatures lower than 12.8 °C.

In the outdoor air, the vapour concentration varies over the year. In winter, it can be 2–4 g/m<sup>3</sup>. In the summer, when there is a lot of evaporation, it may be as much as 7–10 g/m<sup>3</sup>. The temperature variations over the year mean that the RH is lower in the summer than in the winter. It can be estimated that the RH is 85 % in the winter and 70 % in the summer.

Extra moisture is added to the indoor air by people, washing, cooking, showering, and so on. The amount of additional moisture in the air depends on our behaviour, our way of life and our indoor habits, as well as on the ventilation. When measuring the difference in vapour concentration between the outdoor air and indoor air, the difference – that is to say, the additional moisture – is normally in the order of 2–4 g/m<sup>3</sup>.

As far as roofs are concerned, condensation can form inside the structure or as surface condensation on the inside of the roof. As it is the difference between the vapour concentrations that causes diffusion, it is pos-

sible to calculate whether there is a risk of condensation forming inside a roof structure. The direction of diffusion in a completed building – when the building damp has dried off – is normally from the inside to the outside.

Vapour on its way out through a roof is cooled and can reach the temperature at which the saturation vapour concentration is attained. Water which then precipitates can result in problems with damp and mould.

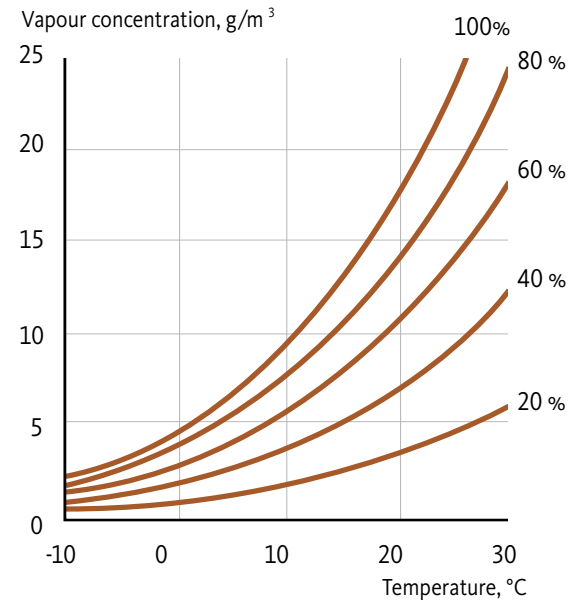

Figure: Link between temperature, vapour concentration and relative humidity.

The resistance of the materials to water vapour migration must be greater on the inside than on the outside in order to prevent harmful diffusion through the roof. Information on the resistance of various materials to water vapour migration can be found in collections of statistical tables.

A limited amount of condensation inside an exterior wall is permissible, on the condition that this condensation can be drawn or drained off, or if the moisture can be stored in such a manner as to evaporate when the temperature and moisture ratios change. The same is true for the underside of roofs.

The risk of condensation forming can be verified by calculating the distribution of vapour concentration through the exterior wall.

## Surface condensation

On roofs, condensation can form in spite of the fact that both the sealing layers and the airtight seal are as tight as possible. The reason for this is that the surface may attain a temperature which is lower than the saturation temperature of the ambient air. The temperature and the vapour concentration of the air are factors which result in the formation of surface condensation. The dew point is the lowest temperature to which damp air can fall without moisture being precipitated out of the air in the form of condensation.

In some cases, the temperature of the surface of the roof can be up to 10° lower than the air temperature. If condensation forms as a result of a sequence of cold nights, this can eventually result in the formation of a thick layer of ice. When the weather gets warmer and the ice melts, water can then form on the roof, in spite of the fact that the roof is apparently fault-free and in good repair.

Surface condensation on the inside of the roof can also form when there is snow on the roof in combination with warm weather outside (temperatures above 0 °C).

Problems with surface condensation occur mostly in the case of sheeting where there is no underlay for draining water off. Wood panels can temporarily absorb a certain amount of moisture, but not more than can evaporate when the vapour concentration in the air is reduced.

The criterion for the prevention of surface condensation on the inside of a roof is expressed mathematically as follows:

$$T_s > T_{sat i}$$

where  $T_s$  = atmospheric temperature, and  
 $T_{sat i}$  = dew point for the specific damp indoor air.

## Convection

Vapour concentration can be transferred by air motion – that is to say, by convection – as well as by diffusion. Diffusion and convection can lead to damages to material.

Convection is caused by the differences in air pressure which come about on account of temperature fluctuations, the wind blowing and ventilation systems, when

the air pressure switches from high to low. When the air moves from a warm to a cold area, there is a risk of condensation forming when the warm, damp air is cooled.

Air flows through roofs and exterior walls can be caused by leaking sections, holes and openings. Moreover, as a rule there is a latent positive pressure indoors which in itself is a risk factor in respect of the convection of moisture through the roof. This positive pressure is augmented by incorrectly installed ventilation systems and/or the wind blowing. In buildings with a constant high internal moisture load, there is a greater risk of warm, damp air penetrating up and out through the roof.

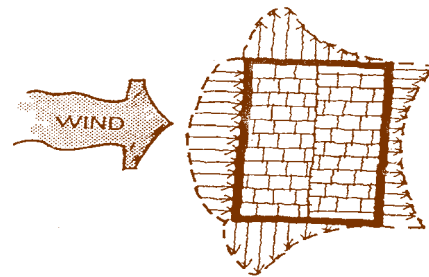

Wind blowing on a house, with pressure on the windward side and suction on the other sides. The wind blowing, incorrectly installed ventilation systems and internal positive pressure are factors which increase the risk of convection.

It can be difficult to calculate the air flow through a roof or an exterior wall due to convection, but it is possible to do this using the theories applied in hydrodynamics.

The safest method to prevent convection through the roof or exterior wall is to use an airtight structure on the inside of the roof or wall.

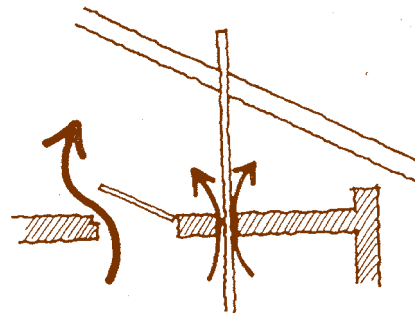

When there are leaks in attic ceilings or in a homogeneous roof structure, convection can lead to warm, damp air penetrating up through the structure and condensation forming on the underside of the roof.

## Building damp

Building damp is the excess water which is present in the construction materials when they are manufactured and supplied, and also appearing in the construction phase. This water has to dry out until the level of moisture in the building is in equilibrium with the ambient moisture level. Building damp must be allowed to dry out before any sealed outer layer is fitted.

Concrete and lightweight concrete are examples of materials which contain a lot of water and need a long time to dry out. The moisture level can be reduced by opting to use materials which have recognised low accumulations of moisture and by using weatherproofing during the construction phase.

In the case of attic ceilings made of concrete or lightweight concrete, it is necessary to ensure that drying out does not take place in such a way that moisture rises up into the roof insulation. Placing polyethylene film over the ceiling (the material that has to dry out) means that the moisture-laden air which comes out of the material is directed downwards. The surface material on the inside must then be selected with this in mind so that the concrete or lightweight concrete is given the opportunity to dry out.

With some type of roof structure the properties of moisture must seriously be taken into account, for example when there are no opportunities for the material to dry out. Internal moisture can also “migrate” in various ways between the inside and outside of a structure and thus cause damage.

The moisture sensitivity of materials indicates how they are affected by moisture in various ways. Manufacturers of materials often specify what is known as the critical RH for their materials.

In the case of roofs and facades, wood and wood-based materials are most often used in the underlay or structural elements, and these can be affected in the event of a high RH. There may be a number of critical moisture values for one and the same material. In the case of wood, the threshold for mould is slightly more than 70 %, while the threshold for acceptable expansion is at around 60 % RH.

RISK OF THE GROWTH OF ROT AND MOULD IN WOOD			
	None	Slight Moderate	Great
<b>Rot</b>			
Moisture ratio	<16	16–25	>25
RH, %	<75	75–95	>95
<b>Mould</b>			
Moisture ratio	<15	15–20	>25
RH, %	<70	70–85	>85

## MOVEMENTS AND MOVEMENT JOINTS

When designing and manufacturing copper structures, it is important to take into account movements and forces – in both the roofing and facade materials and between the various building materials used – which manifest themselves in the event of temperature variations.

Facade claddings and roof coverings may be subject to major temperature fluctuations both during single 24-hour periods and over the course of a calendar year. It is important to be aware of this so as to be able to design movement joints and details for roof coverings and wall claddings in the right way.

All materials react: they either shrink or expand when the temperature changes. It is necessary to take into account the coefficient of thermal expansion of each material in order to reliably determine the degree of change. This is expressed as the movement which occurs in the material in the event of a 1 °C change in the temperature.

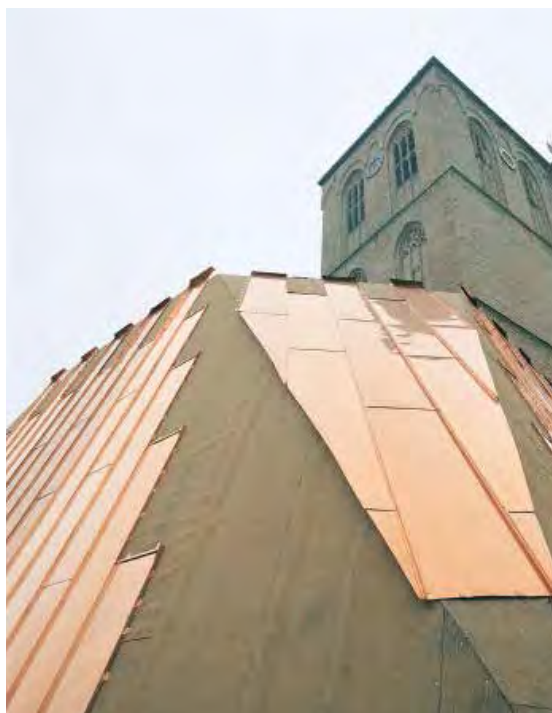

Facade claddings and roof covering may be subject to major temperature fluctuations. A copper sheet of 1 m has a thermal expansion of 1.7 mm with a temperature difference of 100 °C.

The longitudinal change  $\Delta l$  can be described by means of the formula below (formula 1):

$$\Delta l = L \times \alpha \times (t_2 - t_1) = \Delta l = L \times \alpha \times \Delta t$$

where:

L = length of the sheet

$\alpha$  = coefficient of thermal expansion

$t_2$  = design sheet temperature, and

$t_1$  = sheet temperature at the time of installation

$\Delta t$  = difference in temperature

The temperature of the sheet on a really hot summer day can rise to almost +75 °C. If the temperature is +20 °C at the time the sheet is installed, this means that a copper sheet 15 metres long can expand longitudinally by:

$$\Delta l = 15 \times 17 \times 10^{-6} \times 55 = 0.0140 \text{ m} = 14,0 \text{ mm}$$

If the temperature of the sheet in severe cold conditions is - 25 °C, this will result in the longitudinal reduction of the sheet equivalent to:

$$\Delta l = 15 \times 17 \times 10^{-6} \times 45 = 0.011 \text{ m} = 11.0 \text{ mm}$$

As can be seen from the above examples, the temperature conditions at the time the sheet is installed are crucial to how great the longitudinal changes can be. This provides a basis for the degree of movement which must be permitted by movement joints and details so that no damage is caused to the sheeting or to connecting building components and materials.

MATERIAL	COEFFICIENT OF THERMAL EXPANSION AT °C <sup>-1</sup>	COEFFICIENT OF THERMAL EXPANSION PER METRE AT TEMPERATURE DIFFERENCE OF 100 °C
Aluminium	23 x 10 <sup>-6</sup>	2.3 mm
Lead	29 x 10 <sup>-6</sup>	2.9 mm
Copper	17 x 10 <sup>-6</sup>	1.7 mm
Brass	19 x 10 <sup>-6</sup>	1.9 mm
Non-alloy steel	12 x 10 <sup>-6</sup>	1.2 mm
Stainless steel	16 x 10 <sup>-6</sup>	1.6 mm
Titanium zinc	22 x 10 <sup>-6</sup>	2.2 mm

Table: The coefficient of thermal expansion of various metals. The values stated relate to the temperature interval which can occur on roofs and facades.



The movements which can occur in the sheeting must be taken into account when designing details, fasteners, etc. It is important also to take into account possible movements in the underlay. In some instances, movements in the underlay can interact with the movements in the sheeting, which thus means that the values calculated are somewhat “on the safe side”. In some cases, the underlay moves, but not the sheeting. Movements in the movement joints of the framework provide us with an example of this phenomenon. In some instances, the movements of the sheeting may be completely subordinate to the movements which occur in the framework, and the sheet structure therefore has to be designed with this in mind.

### Many different factors affect the temperature

Roofs and facades can be subject to great fluctuations in temperature. Specific factors include:

- » air temperature
- » intensity of solar radiation
- » wind speed
- » the ability of the surface to dissipate heat
- » the thermal resistance and thermal capacity of the roof/exterior wall.

Approximate values for the absorption factors of some of our most common colours and materials.

ABSORPTION FACTOR		
Colour, surface	New materials	Aged materials
Grey, dark green	$a = 0.7$	$a = 0.7$
Light	$a = 0.4$	$a = 0.5$
Dark, black	$a = 0.9$	$a = 0.9$
White	$a = 0.2$	$a = 0.4$
Aluminium sheeting	$a = 0.25$	$a = 0.4-0.5$
Copper sheeting	$a = 0.3-0.4$	$a = 0.9$
Metal-coated sheeting	$a = 0.25$	$a = 0.6-0.8$
Stainless steel sheeting	$a = 0.25$	$a = 0.4$

The movements which can occur in the sheeting must be taken into account.

When estimating the greatest possible degree of movement, of sheet lengths and fasteners, it is the extreme values in respect of temperature differences which are of most interest. However, there is a great risk of fatigue and damage caused by movement, even if the movement is minor but occurs quickly and often. For example, a thunderstorm on a hot summer day may result in a rapid shift in the temperature of the sheet from +75 °C to +15 °C.

The greatest temperature differences during one and the same 24-hour period can be found in periods of clear weather with strong solar incident radiation during the daytime and the intense emission of heat overnight. The greatest temperature differences over short periods occur at dawn or dusk, or in conjunction with rain, snow, sleet or hail. The lowest temperatures occur during clear nights with a high level of heat emission.

The highest temperatures on roof surfaces can be calculated using the equivalent temperature:

$$T_e = T_1 + m_u \times a \times l$$

where:

$T_e$  = equivalent outdoor temperature (°C)

$T_1$  = air temperature (°C)

$a$  = roof surface absorption factor

$l$  = total solar incident radiation (W/m<sup>2</sup>), and

$m_u$  = surface coefficient of heat transfer at the surface (m<sup>2</sup> °C/W)



According to the equation, the equivalent outdoor temperature will be the same as the atmospheric temperature if the underlay is infinitely heat-insulating. However, it is usually used as an approximate value for calculating the atmospheric temperature in such contexts.

The thermal surface resistance  $m_u$  is dependent on, inter alia, the air speed at the surface. In the case of protected sections, a value of 0.07 is used, while in exposed positions or in strong winds, this value can be 0.04–0.05.

The colour and structure of the material are factors which affect the temperature at the surface of the material. The effects of these characteristics on the temperature of the material (the absorption factor) are shown in the table above.

### Example

On a sunny day in summer, the solar incident radiation can amount to more than  $1\,000\text{ W/m}^2$  on a flat metal roof. With an air temperature of  $+28\text{ }^\circ\text{C}$  and a copper sheet surface where  $a = 0.9$  and the thermal surface resistance  $m_u = 0.05\text{ m}^2\text{ }^\circ\text{C/W}$ , the equivalent temperature, according to Formula 2, equals approximately  $+75\text{ }^\circ\text{C}$ . (The temperature is approximately 10 % lower in the case of profiled surfaces.)

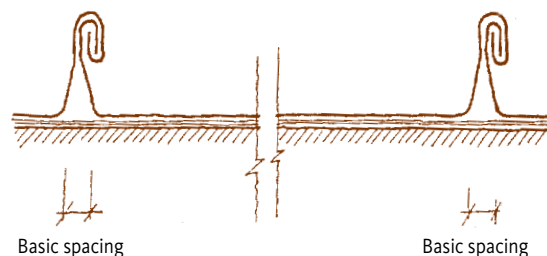

In the case of seamed sheeting, lateral movements are absorbed by the basic spacing which must exist between the standing seams. This basic spacing is also important in order to minimise the risk of rise between the seams. A lot of rise can be one cause of noise in a metal roof.

Flat sheet metal can absorb thermal movement across the standing seams provided the seams are designed to accept the appropriate amount of expansion. Longitudinally, the sheet is able to move freely if it is attached using sliding clips and including a degree of movement at either or both ends. The lock welt is used across the width of the sheet. In the case of copper sheeting, a double lock welt is normally used irrespective of the slope. The double lock welt must be fitted such that it is able to absorb the thermal movements of the seam. Therefore, the edges of the sheeting do not reach the bottom of the double fold of the seam. In the case of panel covering, a degree of movement of 1.5–2.0 mm is normally used in the double lock welt.

When the plates are laid at right angles to one another in the case of strip covering or double lock panel covering, it is important to bear in mind the fact that the material will move in two different directions. Strips and panels made of flat sheeting and laid with no degree of movement will result in wrinkling and dents. If the movement of the material is repeated, these will develop into cracks in the sheeting.



## Movements in the underlay or framework

Movements in the underlay can result in damage to the copper roof. It is possible to prevent such damage from occurring by laying weatherproofing mats and cloths on obstructions and allowing the sheeting to overlap the mat or cloth. However, there is one area in which this is not practicable – at edge sheets in connection with gutters or box gutters.

Movement joints in the framework are created in order to absorb the material movements between various parts of the structure. These joints can be designed in fairly great detail and on the basis of anticipated movements in the material.

## Fixed zones and movable zones – strip lengths

In the case of strip covering or double lock long panel coverings, attachments and connections to other building components, as well as free channels, should be designed in such a way as to restrict the thermal movements or to ensure that these can be absorbed without causing damage.

The term “longest strip length” is used in these contexts in order to indicate how long the strips are permitted to be between movement joints in the direction of slope of the roof. The adjacent figure shows that the movements of the strips are assumed to originate from the centre of movement, or fixed zone.

The centre of movement can be placed at the eaves, in the middle of the roof, at ridges or against a high wall. In the case of steeply sloping roofs, it is generally recommended that the fixed zone be placed at ridges.

The fixed zone must be apparent from drawings and job specifications as this is an important criterion when it comes to dimensioning attachments and designing details. In the fixed zone, it is assumed that the strips will be locked in position to details, roof safety systems with through joints or the like using fixed clips. If the strips are locked in position at more than one point lengthwise along the roof, or if the recommended strip lengths are exceeded, a movement joint must be placed between these points.

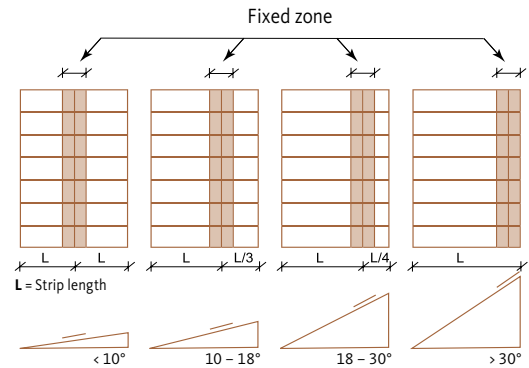

The position of the fixed zone at various roof slopes. In the case of steeply sloping roofs, it is appropriate to place the fixed zone at ridges. If the fixed zone is placed in the middle of the roof, one strip length can be laid upwards from the fixed zone, and one can be laid downwards from it. In the case of copper sheeting, this means a continuous total strip length of 16 m. The fixed zone should be 2 to 3 m in length. If the total strip length is less than 10 m, the fixed zone should be 1.5 m in length.

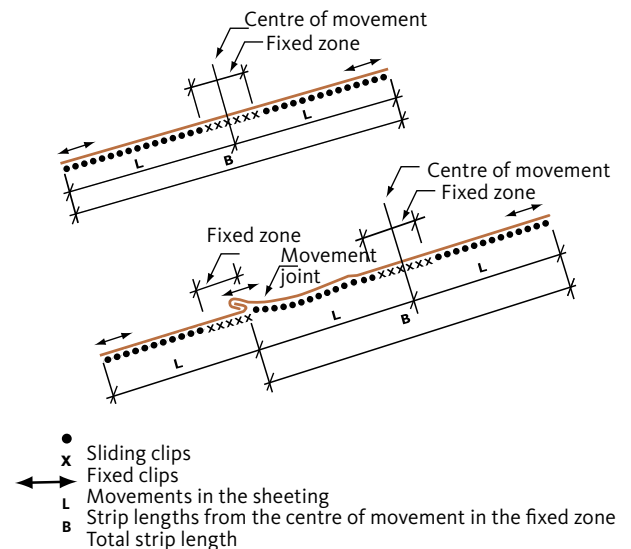

Fixed and movable zones at a strip covering or double lock long panel covering. The fixed zone and movement joint must be positioned in the same place along the roof.

The recommended maximum strip length is 8 m in the case of copper sheeting. Sliding clips with a high degree of movement should be able to permit greater strip lengths to be used. However, it should be borne in mind that strips longer than 8 m will be difficult to handle.

The movement joint can be set up in different ways depending on the slope of the roof. It is important to pay attention to the demands for tightness against the penetration of water. This may mean that the movement joint has to be raised or for the connection to be made using edge sheets to protect against the penetration of water.

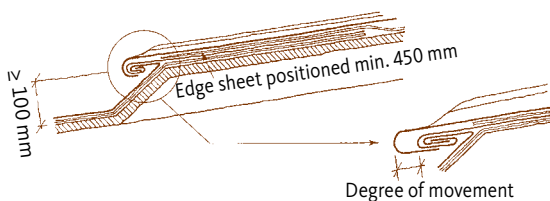

**Movement joint with raised slope.** This type of movement joint should be used for gently sloping roofs. The rise means that water has to ascend by 100 mm before it is able to penetrate the connection.

Note that the edge sheet is attached to the sheet below – which may be a valley or a roof covering – by means of a double seam. It is important that no nails are driven through the edge sheet, partly on account of the fact that it should remain sealed, and partly on account of longitudinal movements which have to be absorbed in the case of valleys or the like.

In the case of slopes in excess of 18°, it is possible to make a movement joint without a structure. This movement joint can then be created using soldered on mounting plates. If the slope is even steeper (more than 30°), the movement joint can be constructed as an enlarged single lock welt.

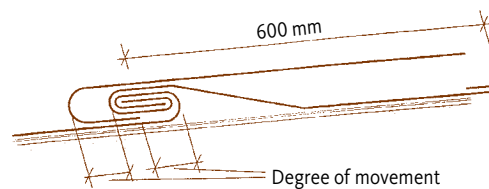

**Movement joint with seamed edge sheet.** This method is used where soldering would be inappropriate. Note that the edge sheet is terminated using a capillary break. Clips which permit movement in two directions can be fitted in this capillary break. The slope of the roof should be in excess of 14°. Sealing grease in the movement joint will provide protection against the penetration of water.

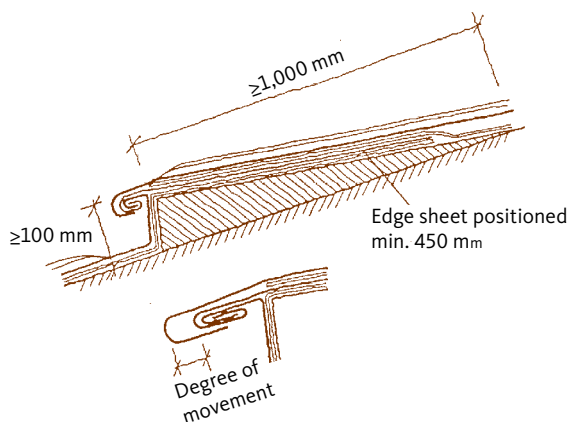

This solution can be used for slightly steeper slopes as an alternative to the solution outlined in the figure above. An edge sheet is used for this option too, in accordance with the same principles as shown in the figure above.

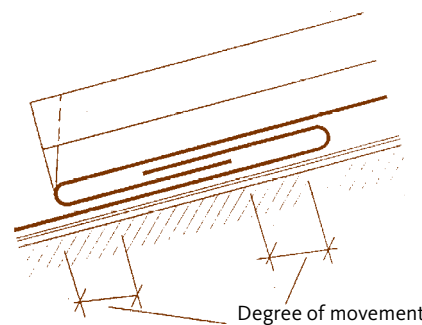

An enlarged single lock welt can be used for steeply sloping roofs where there is little risk of water penetrating. The slope of the roof should be greater than 30°.

### Movement joints at ridges

If the fixed zone is positioned in such a way that movement is to take place against a ridge or sloping ridge, the ridge seam must be raised and have a basic spacing which is larger than that of a standard standing seam. The height of the sloping ridge should be three times the degree of movement to be absorbed. However, the sloping ridge should always be made no less than 50 mm high.

### Movement joints at overhangs and edges

The need for a degree of movement must be taken into account when connecting free edges to roof overhangs, gutters, box gutters or recessed valleys. It is possible to establish how great the degree of movement should be on the basis of strip lengths and the position of the fixed zone. It is important to remember that the movements in a valley can run at right angles to the connecting strips. Therefore, it is essential to bear in mind both the demands in respect of the movement required as well as the demands for tightness.

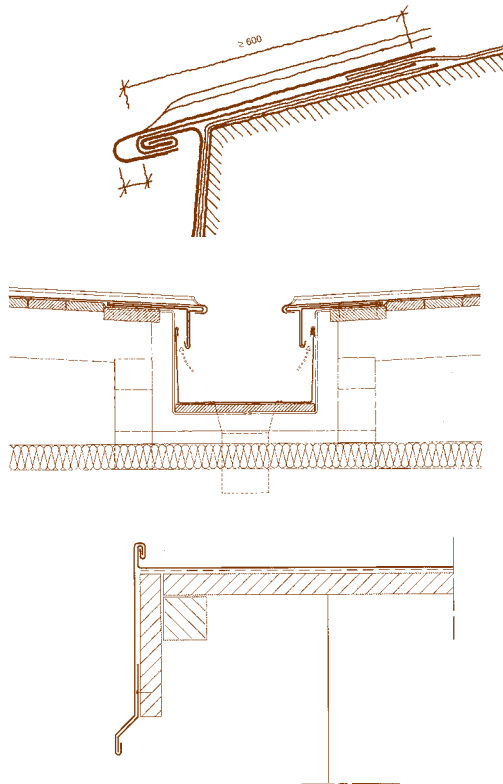

When terminating sheeting against high walls, the need for degree of movement must also be taken into account.

Termination of a roof covering with a degree of movement towards a valley. Remember not to drive any nails through the edge sheet but to clip it into position using hook bolts so as not to impair the movements lengthwise along the valley.

Termination of a roof covering with a degree of movement towards a recessed valley. The example also shows how the boarding in at the edge sheet has been placed slightly lower in order to compensate for the raising of the level resulting from the edge sheet, mounting plate and even the underlay felt.

In the case of suspension plates, the movements can be absorbed if the joint is effected by means of a continuous mounting plate. When the roof covering moves, the suspension plate will follow the movements, sliding against the mounting plate. Therefore, it is incorrect to nail the suspension plate into position.



A cover flashing lying parallel to the pitched roof area. The cover flashing can move freely in relation to the connecting wall because it has been attached using hook bolts. The cover moulding protects the connection.

### Movement joints for connecting walls

The need for a degree of movement must also be taken into account when terminating sheeting against high walls, ridges, structures and the like. This can be done in different ways depending on the slope of the roof, the sheeting used and how the connecting details are made.

A cover flashing lying parallel to the slope of the roof can be made the same length as the roof covering as it will follow the movements of this covering. Note that the cover flashing must not be connected to the material lying beneath it using through joints.

A cover flashing lying parallel to the pitched roof area. The movements between the cover flashing and the wall cladding are absorbed by the seam that is structured as a single lock welt.

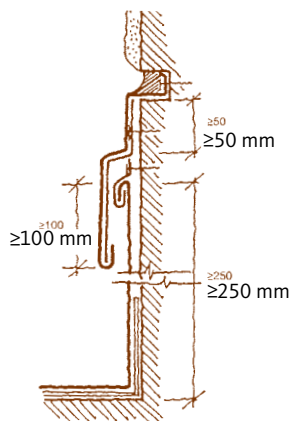

One alternative to a cover flashing with tapered seams would be to run the covering up a connecting wall with the standing seams unbroken. This would then result in standing seams with folds which would allow the movements across the sheeting to be absorbed in the same way as in the covering. This method demands great precision as gaps can easily occur in the folds.

Another option is to make the connection using a structure in more or less the same way as with a movement joint in the roof covering. The cover flashing can either be created as a strip or with double cross-joints connected flexibly to a high wall and also to the roof covering beneath it.

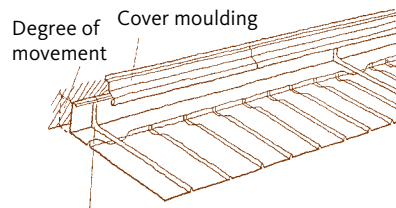

Tapered seam with movement-absorbing function

A cover flashing lying at right angles to the pitched roof area. Here, there has to be a degree of movement – both in the cover flashing, and against the connecting wall. It is important for the cover flashing not to be made too long and for it to be divided up by means of tapered seams, which must be made in a single piece with the nearest standing seam.

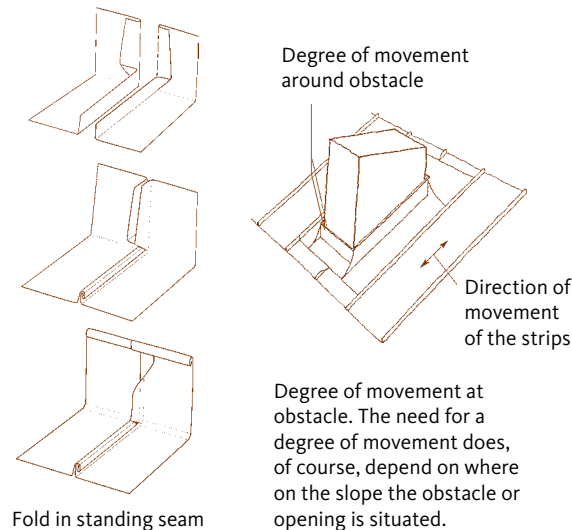

## Movement joints at openings

The need for a degree of movement must also be taken into account at openings, pipe flashings, hatches, roof lights, chimneys etc. This can be done according to the principles described in the previous section. It is important that there is a sufficient degree of movement both across and along the roof covering and that the connections are made so as not to impede movement.

Through joints can impede movement if they are positioned incorrectly. This can initially lead to leaks

via the holes because these are enlarged due to the movement of the material. This can be witnessed in roof safety arrangements fitted using through joints, for example. Therefore, it is appropriate to combine this kind of roof safety arrangement with the fixed zone of the roof covering. If aerials, struts and the like are fitted after the roof covering has been constructed, it may be appropriate to attach these to a seam so as not to have to perforate the sheet.

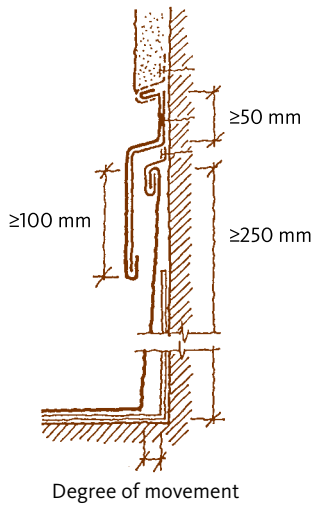

Principle for the degree of movement towards high walls or obstacles lying across the pitched roof area.

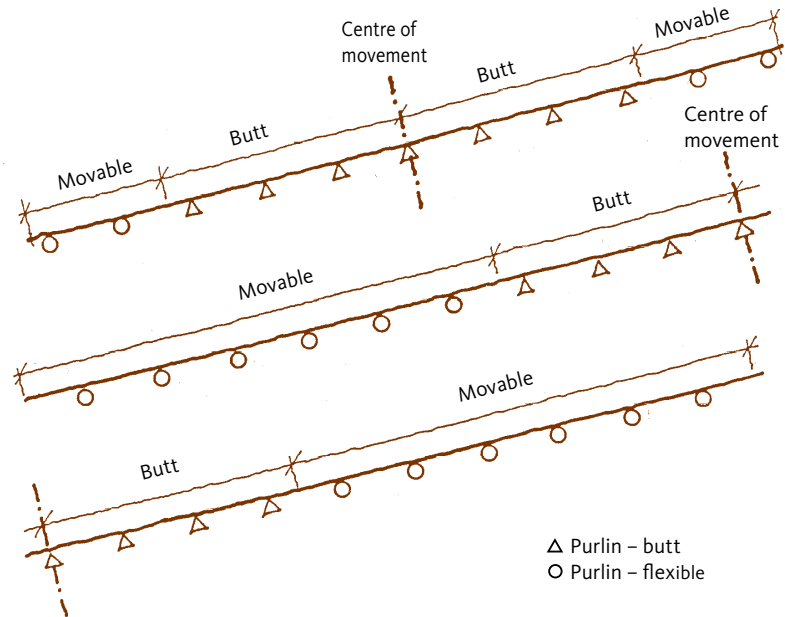

Continuous sheet length, movable and butt joints in profiled sheeting.



Attachment of a ridge rail with seam attachment which does not prevent the movement of the covering. There are a number of different kinds of seam attachments.

### **Movement joints in profiled copper**

In the case of roof coverings or facade cladding using profiled copper, thermal movements must be taken into consideration as well. This applies not only to the fasteners, but also, where applicable, at terminations and towards details as outlined in the previous section.

A butt joint can be used to attach profiled copper sheeting if the continuous sheet length is no more than 3.5 m. The continuous sheet length is calculated from the centre of movement as shown in the illustration below. The continuous sheet length is the distance between the outermost attachments where movements can be absorbed without damage being sustained by the sheeting.

This may be one sheet or a number of sheets which are interlocked longitudinally.

The centre of movement is that point in the covering or cladding, at right angles to the length of the sheet, where no movement takes place.

A screw in the profile base attached to a steel girder is one example of a butt joint.

If the continuous sheet length exceeds 3.5 m, the need for movement must be taken into account. This is normally done in accordance with two principles:

- » flexible purlins
- » movable lap joints

Z-bars or other types of steel girder are all types of flexible purlin which follow the thermal movements of the profiled sheeting. Remember that it is important to follow the manufacturer's instructions as regards the types of bars, joints, etc. to use. It is also possible that the flexible purlins have to be combined with movable lap joints when large sheet lengths are used.

As is the case with roof coverings made of flat sheet, it is important that the centre of movement, as well as the positioning of both movable lap joints and butt joints, are described in the documentation, either in the drawings or in the descriptions.



### Butt joints and movable lap joints on roofs

The two illustrations below show the difference between butt joints and movable lap joints on roofs. In the case of shallow slopes, there may be just cause to increase the length of the overlap on account of the risk of the penetration of water. When a covering is to be effected with a certain degree of curvature, it should also be noted that preformed sheeting must be used. If preformed sheeting is not used, it may be difficult to get the overlap to fit.

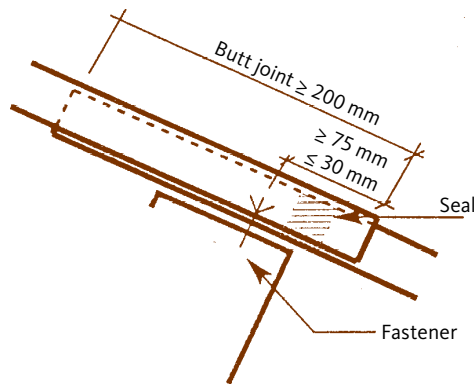

Butt joint on roof. A seal must always be attached to the joint.

### Butt joints and movable lap joints on walls

The two illustrations below show the difference between butt joints and movable lap joints on walls. The joints are smaller than those used on roofs. No seals are used.

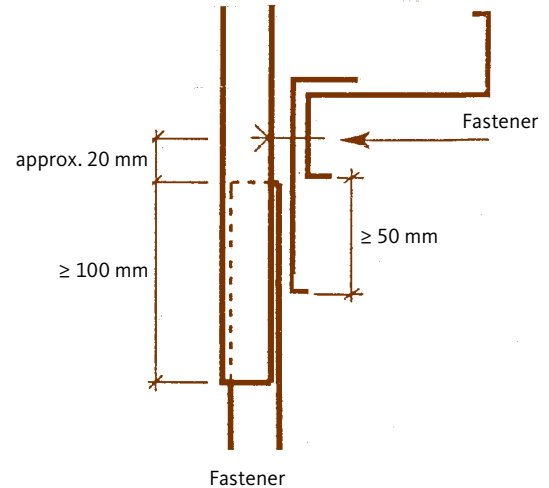

Movable lap joint on wall. Note that the purlin has to be larger than for butt joints.

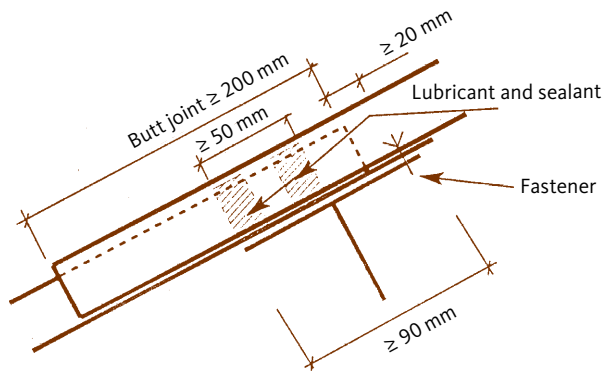

Movable lap joint on roof. Note that in this case the seal has to be effected in two rows. By using sealing grease, the seal also acts as a lubricant between the sheets.

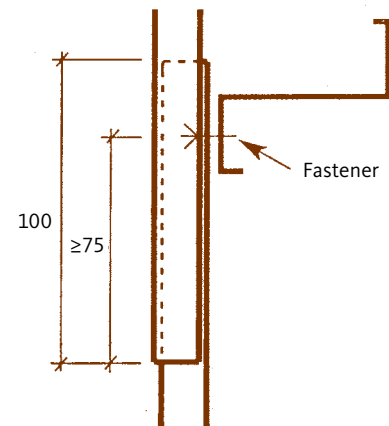

Butt joint on wall.

## Flashings and mouldings

Various kinds of flashings and mouldings can be found on facades, ridges and structures; window edge flashings, facade mouldings, etc. If these are more than 2 m long, they may need to be joined. Joints made using single lock welts or double lock welts, depending on the slope of the flashing or moulding, are most common. In some cases, lock joints or overlaps (when jointing flashings) are recommended.

Special movement joints may also be required for these details, depending on the sheet length and design of the seam or joint. These are required if butt joints are created by means of overlaps riveted or screwed together. There are a number of different methods for designing joints so as to prevent damage from occurring on account of water penetrating them.

One method is to design the joint with ends, and upper seams and standing seams, slightly higher than usual and with larger clips. Movements are thus absorbed by the basic spacing. This type of joint can be used for window edge flashings and facade mouldings when other joints are created with double lock welts. If the sheet is too thick to permit welded seams to be created, it is possible to use joints with underlying sealing strips (as shown in the illustration) as an alternative to ends with upper seams. When this type of joint is used, it is important to supplement the sealing strip with seals and to connect it to the wall behind in such a manner that water is unable to penetrate into the structure beneath.

In the case of ridges with an underlying sealing layer, it is possible to create the movement joint as an enlarged overlap with capillary breaks. If this arrangement is used, the sheets must not be joined together using rivets or screws in the overlap.

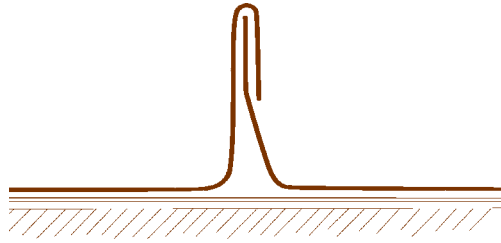

End with upper seam.



Lock joint with sealing strip.



Joint - edge to edge with a sealing strip. This arrangement is used for preference when thick sheet metal is used.



Enlarged overlap with seal and capillary break.

# Attachments and wind loads

Buildings are subject to many different types of external stresses during their lifetime, and the fasteners are often the most vulnerable part of the protective shell of the building, in particularly in relation to corrosion.

Attachment systems which work well must also be sufficiently strong and be of the correct ergonomic design. The fasteners must be tight and easy to identify.

The choice of fasteners affects the overall service life of the building. It is necessary to comply with a range of functions if the fasteners are to work as well as possible. Of course, they must be able to withstand all the anticipated loads and environmentally significant stresses, but they also have to offer the best options as regards fitting.

One good basic rule to apply for all attachment techniques is that the service life of the fasteners must be longer than that of the material to be attached. Therefore, fasteners made of stainless steel are always preferable for use outdoors.

The following are basic demands which are made of the fasteners in attachment systems:

- » the requisite strength
- » corrosion resistance
- » tightness against rain, snow, sleet and hail
- » a high level of mountability (ergonomically designed and adapted) and identifiable labelling In the case of fasteners to be fitted outdoors, it is recommended that these be made of stainless steel.

Fasteners made of austenitic stainless steel, EN 10 088-3.4301, are recommended for use in environments classified under corrosivity class C3 or C4. In the case of fasteners to be used in environments classified under corrosivity class C5-I or C5-M, steel quality EN 10 088-3-1.4436 is recommended.

## Strength

Loads can occur in joints which can lead to fractures under unfavourable conditions (incorrect dimensioning or fitting). Therefore, joints have to be dimensioned in a relevant manner and on the basis of potential loading which has been calculated realistically.

Calculation criteria and dimensioning values for fasteners and the attaching of these to various bases and for combination with one another are generally specified in the instructions issued by the manufacturer of the fasteners.

## Tightness

Nowadays, profiled sheeting is mainly attached to roofs and facades in the base of the profile using screws and grommets. It is extremely important to check that the grommets are designed correctly and made of a reliable material so as to ensure that they are not affected by movements in the material caused by temperature fluctuations, damp, UV radiation, aggressive air pollution, and so on. Flexible grommets made of vulcanised ethylene propylene diene rubber (EPDM) meet these requirements.

## Labelling

It must be possible to identify all fasteners in respect of their manufacturer, quality and technical performance. All fasteners must be labelled so as to permit their origins to be traced.

## Wind loads

Fasteners for roof and wall claddings made of sheet metal are affected primarily by the suction caused by the wind. The design wind load is determined by the height, architecture, material composition, ground conditions and geographical location of the building.

– The effects of the wind load are determined by various form factors ( $\mu$ ) and a characteristic value of the wind speed pressure ( $q_k$ ).

– The form factor ( $\mu$ ) is dependent on the wind direction and the geometrical design of the building. Examples of roof form factors can be seen in the illustration.

The characteristic value of the wind speed pressure ( $q_k$ ) is dependent on the reference wind speed ( $v_{ref}$ ), the ground type and the height ( $h$ ) of the building.

Examples of speed pressures ( $q_k$ ) for ground type 1 can be seen in the table below.

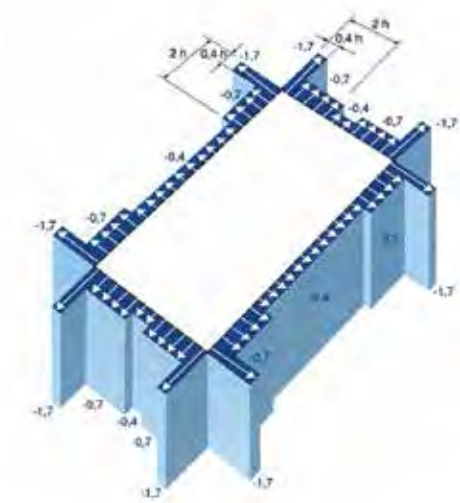

Form factors for maximum wind load for walls. It is assumed that the width and length are at least twice the height of the ridge.

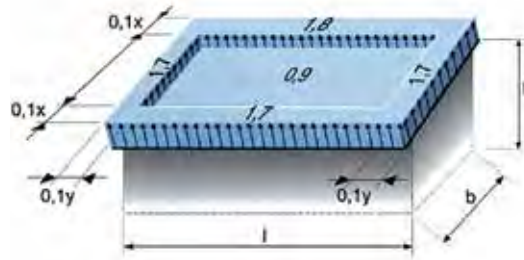

$x$  = minimum value of  $l$  or  $2h$   
 $y$  = minimum value of  $b$  or  $2h$

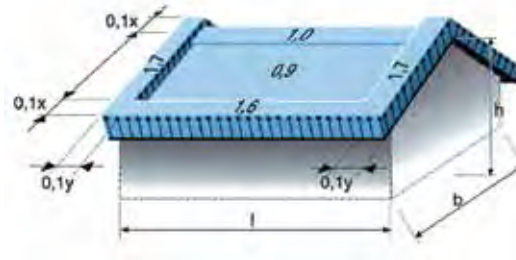

Form factors for maximum wind load on facing (+30%) for pitched roof and monopitched roof, with slope  $> 5^\circ$ .

SPEED PRESSURES (kN/m <sup>2</sup> )						
Height (m)	21 m/s	22 m/s	23 m/s	24 m/s	25 m/s	26 m/s
2	0.48	0.52	0.57	0.62	0.68	0.73
4	0.57	0.63	0.69	0.75	0.81	0.88
8	0.68	0.74	0.81	0.88	0.96	1.04
12	0.74	0.81	0.89	0.97	1.05	1.13
16	0.79	0.86	0.94	1.03	1.11	1.21
20	0.82	0.90	0.99	1.08	1.17	1.26
25	0.86	0.95	1.03	1.13	1.22	1.32

In what are known as the edge zones along the outer edges of the building, the wind suction can be two to three times greater than on inner surfaces. At the outer edges of a roof, the wind suction can be six to eight times greater than inside the roof.

The design wind suction load effect is calculated as follows for each zone:

$$q_d^3 = 1.3 \times \mu \times q_k \text{ (kN/m}^2\text{)}$$

where

$q_d$  = design value for wind load effect

$\mu$  = form factor

1.3 = particle coefficient for variable load

$q_k$  = characteristic speed pressure

### Recommendations for attachment of seamed sheeting in respect of wind load

Clips should be attached using screws. Two screws per clip is normally sufficient. Alternatively, clips may be designed and attached differently in a way which results in comparable strength.

The norm for the greatest distance between clips varies all over Europe. In Sweden, clips must be fitted spaced at no more than 450 mm intervals along the seam. This dimension is based on tried and tested experience of nailed clips. Nails have considerably lower design extraction values than screws, and generally two nails are required for each clip. It should be noted that the extraction load for nails is reduced when timber dries.

Given that attaching clips using screws means that the clips can be spaced further apart, it may be interesting to find out whether a greater space between clips would be possible without impairing the rigidity and flexural strength of the seam.

In exposed areas, a design inspection of primarily edge zones must always be carried out.

### Recommendation regarding clip spacing: screw attachment of clips in 23 mm wood panel

#### Criteria:

**Seam spacing:** 600 mm or 450 mm

**Base:** 23 mm wood panel

**Fasteners:** Stainless clip screw, dimensions min. 4.0 x 25 mm

**Roof:** Pitched roof or monopitched roof, slope > 5°– 30°

**Clips:** Breaking strength > 1,000 N

From the criteria above, where the design strength of the extraction load of the screw is known, it is possible to calculate the strength of the sheet attachment against the suction load.

#### Example 1

A roof covering is to be applied in accordance with the strip covering principle to a building in the centre of Stockholm. The maximum height of the building is 15 m, its width is 20 m and its length is also 20 m. The slope of the roof is 14°, and it is of monopitch design. The base for attachment is 23 mm wood panel covered with underlay. Each clip will be fixed by means of 4.0 x 25 mm clip screws.

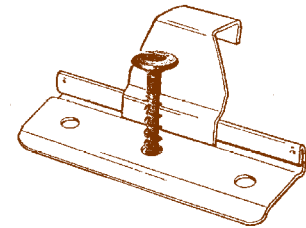

Clip with screw

**Dimensioning:** According to the National Swedish Board of Building, Planning and Housing's document 'Snow and wind loads', the ground type in this instance is IV and the reference wind speed is 24 m/s. This gives a characteristic speed pressure of 0.50 kN/m<sup>2</sup>. Therefore, the design suction load effect will be:

#### Edge zone along eaves:

$$q_d = 1.3 \times -1.7 \times 0.50 = -1.11 \text{ kN/m}^2$$

#### Edge zone along gable wall:

$$q_d = 1.3 \times -1.5 \times 0.50 = -0.98 \text{ kN/m}^2$$

#### Edge zone along ridge (high point):

$$q_d = 1.3 \times -1.8 \times 0.50 = -1.17 \text{ kN/m}^2$$

The inner zone of the roof does not need to be checked. A seam spacing of 600 mm and a clip spacing of 600 mm may be used over the entire roof.

The adjacent table shows the strength of the attachments at various seam and clip spacings. If fasteners other than screws of a minimum of 4.0 x 25 mm are used, of course, similar tables can be drawn up for these.

### Example 2

A roof covering is to be applied in accordance with the strip covering principle to a building on the harbour in Helsingborg. The maximum height of the building is 40 m, its width is 30 m and its length is 40 m. The slope of the roof is 14°, and it is of pitched design. Each slope is 15.5 m. The base for attachment is 23 mm wood panel covered with underlay. Each clip will be fixed by means of 4.0 x 25 mm clip screws.

**Dimensioning:** According to the National Swedish Board of Building, Planning and Housing's document 'Snow and wind loads', the ground type in this instance is I and the reference wind speed is 26 m/s. This gives a characteristic speed pressure of 1.45 kN/m<sup>2</sup>. In this case, the resulting loads will be so great that it is worth calculating the loads strictly in accordance with 'Snow and wind loads'. A factor of 1.30 is to be added for the outer cladding attachment.

The effect will be:

**Edge zone along eaves:**

$$q_d = 1.3 \times -0.8 \times 1.30 \times 1.45 = -1.96 \text{ kN/m}^2$$

**Edge zone along gable wall:**

$$q_d = 1.3 \times -1.2 \times 1.30 \times 1.45 = -2.94 \text{ kN/m}^2$$

**Edge zone along ridge:**

$$q_d = 1.3 \times -0.8 \times 1.30 \times 1.45 = -1.96 \text{ kN/m}^2$$

**Inner zone**

$$q_d = 1.3 \times -0.6 \times 1.45 = -1.13 \text{ kN/m}^2$$

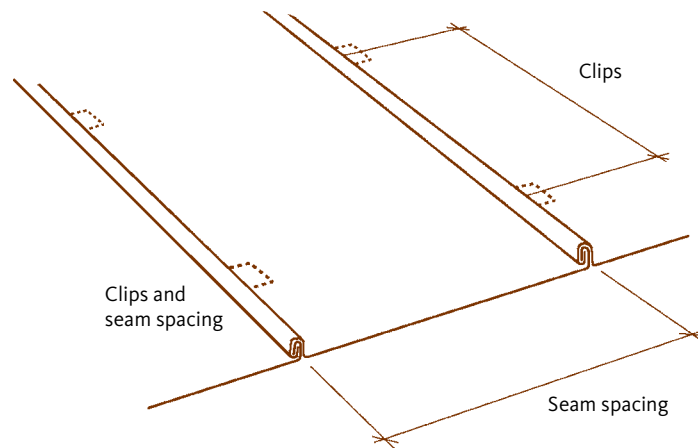

Seam spacing, C seam	Clip spacing, C clip	Position	Design strength of attachment against suction load
600 mm	600 mm	Inner zone	1.6 kN/m <sup>2</sup>
600 mm	450 mm	Edge zone	2.1 kN/m <sup>2</sup>
450 mm	450 mm	Edge zone	2.9 kN/m <sup>2</sup>
Exception: Specific calculations must be carried out for roofs with a slope of < 5°.			

According to the table Design strength of attachment against suction load, a seam spacing of 600 mm and a clip spacing of 600 mm can be used in the inner zone. A seam spacing of 600 mm and a clip spacing of 450 mm should be selected for the zone along the ridge and façade. A seam spacing of 450 mm and a clip spacing of 450 mm are to be used in the edge zone along the gable wall. The size of the edge zones is calculated according to the recommendations given in 'Snow and wind loads'.

When the results of the simplified example 1 exceed the values given in the table, there is just cause to carry out more precise dimensioning in accordance with the instructions given in 'Snow and wind loads'.

# The design of the roof

## THE SLOPE OF THE ROOF

The most important job of the roof has always been to protect everything under it – the building, the home and the people – from rain, snow, sun, matter falling or drifting about, heat and cold, and so on. The high standard of living enjoyed by people today, which includes beautiful houses and good architecture, has made it more and more important to protect the building material, architectonic attractions, technical solutions and personal possessions against the climate and the weather.

In the last few years, the aesthetic appeal of buildings has also become more significant. Nowadays, we refer to architectonic function. The shape and colour of the roof go together with the underlying body of the building to create a complete unit. This has to match and give a beautiful and consistent impression so that the building is perceived as complete and attractive.

There are specific building traditions in every country, founded on both aesthetic and practical considerations. Cultural characteristics – the architecture and choice of materials – are factors for which it is necessary to show respect. They often have their origins in a natural access to building materials with a historical base: the clay was turned into brick, the iron or copper was turned into sheet metal, the slate was turned into slate roofs, and so on. This phenomenon has given us a rich assortment of roof forms, all different, interesting and inspiring.

So which technical, aesthetic and economic considerations should be taken into account in the design of a roof? One thing which is quite obvious is the fact that every “break” in the form of cowlings, dormer windows, doors or openings makes the roof both more costly to construct and more susceptible to fractures and damage.



Roof with no obstructions.

Horizontal and inwards-sloping roofs do not work well under most conditions or in most climates. Water tends to form pools on flat roofs, or to be absorbed between the overlap sheets. The steeper the slope, the more efficient the runoff and “self-cleaning”. Steep roofs are however as a rule more costly from the point of view of building and maintenance.

The slope of the roof is specified using the following terminology:

### Horizontal roofs...

0.0°–0.6° slope, or 1:00–1:100

### Flat roofs...

0.6°–3.6° slope, or 1:100 –1:16

### Shallow sloping roofs...

3.6°–4.0° slope, or 1:16–1:4

### Steep roofs...

> 14° slope, or > 1:4



Steeply sloping roof.

## Steeper than 1:4 – steep roofs

The steeper the roof, the fewer problems there will probably be with water runoff and snow loads, for example. It is certain that, a very steep roof will hardly need to be cleared at all if snow piles up on it.

It can be impractical to stand or work on really steep roofs, and scaffolding may need to be erected along the entire pitched roof area from foot to ridge in order to carry out any work. In the case of roofs sloping at an angle of more than 1:4, sheet-metal workers often apply what is known as a “steep slope supplement” which is set in proportion to the risk of an accident occurring, which in turn is worked out from the angle of slope of the workplace (the roof).

Salary costs for traditional sheet metal covering normally make up 30 %–40 % of the total costs for constructing the roof, including materials. A roof with an angle of slope of 45° and a steep slope supplement for the sheet-metal working results in additional costs of 9 %–12 % when compared with a less steeply sloping roof. To this it is then necessary to add costs for any scaffolding, safety precautions, and so on.

## Less than 1:4

It is less expensive to construct and maintain a weatherproofing layer on a roof with a shallow slope than is the case for a steeply sloping roof. The shallower the slope, however, the more stringent the demands which have to be made of the roof boarding (the flatness) in order to prevent water from forming pools. In fact, the shallower the roof, the greater the risk of minor mistakes being made when producing the weatherproofing layer for it, thereby leading to leaks in the future.

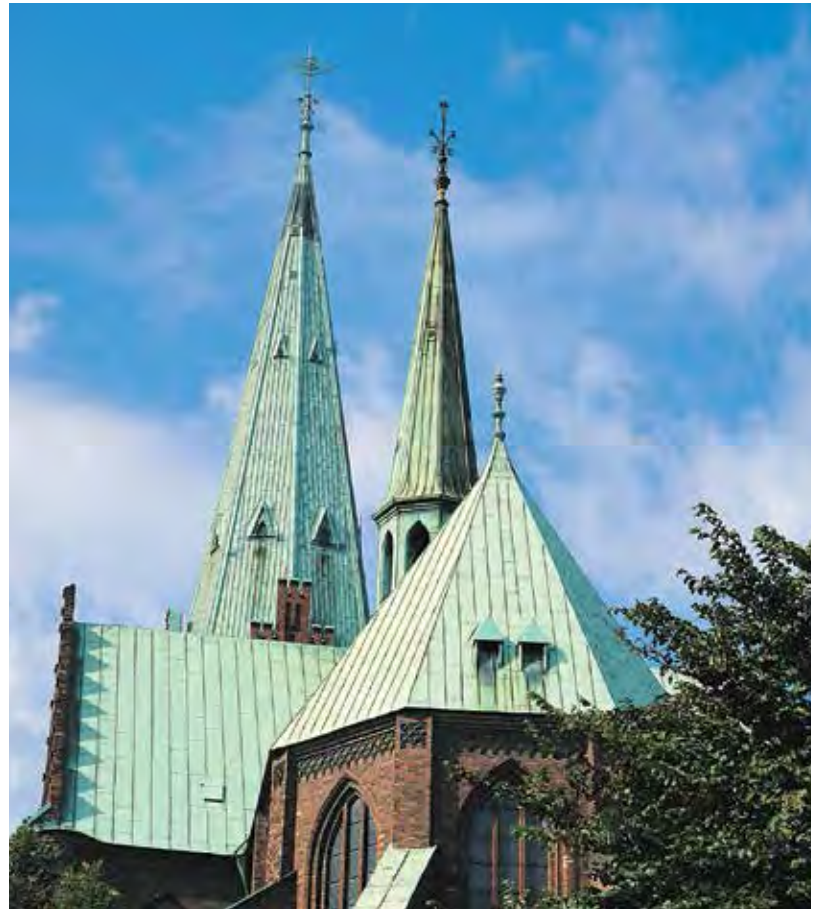

Steeply sloping roof.



Snow slide guard over an entrance.





The positioning of roof penetrations must be marked on the plan.

## ROOFING PLAN

A detailed roofing plan is a must in order to provide an optimal roofing solution. The term “roofing plan” covers a large number of different plans which have to be prepared, such as the wind load plan, the load plan, the attachment plan, the drainage plan, the plan for pipe and cable openings, and so on. These different plans can be combined in a variety of ways. The most important thing is to make sure during planning and design that absolute control is gained over all the parts of the roof.

Work on an attachment plan is made easier if a wind load plan is used as a starting point. Mark the edge zones and how tight the brackets are to be. In positions exposed to the wind, the outer panels and strips can also be made narrower so as to increase the bracket tightness. The positioning of any fixed zones must be marked on the attachment plan. Equipment mounted permanently (access and safety facilities) can be co-ordinated more easily with the fixed zones of the sheet metal. The same applies to openings for pipe flashings, pipes, cabling, etc., which all restrict the degree of movement of the sheet metal in some way.

Roof-mounted access and safety facilities do not need to be made fixed zones. These have mountings which follow the movements of the sheet metal.

It is relatively easy to prepare a seam position plan if an attachment plan is used as the starting point. Having a seam position plan offers obvious benefits, in particular in the case of older buildings and what are known as “cultural buildings”. It gives the craftsman opportunities to use the special surface structure and the pattern characteristic of panel covering, for example. Moreover, it also makes it easy to avoid risky seam joints.

Using a roof plan makes it easier to co-ordinate the positioning of access and safety facilities with protruding sections, openings, ducts which have to be cleaned according to regulations, and chimneys. Using a roof plan as a starting point, it is easier to judge, for example, whether it is worth moving a chimney slightly sideways or to place a catwalk a little further down the pitched roof area. It is easy to determine where the ascent hatch should be positioned in relation to the features which have to be cleaned according to regulations.

Using a roof plan also makes it easier to deem where best to position the water flows, inverts and gulleys. It is also possible to see where there is a risk of standing water, ice, dirt and so on. In particular, mark surfaces with shallow slopes, such as dormer window aprons, terraces or the like.



Access and safety facilities.

Avoid draining off water from one flat surface to another (lower) surface. Free-falling water can cause corrosion or wear to the lower roof and splashes onto the facade material. Water must be drained off and down from the roof by the shortest and simplest route, and via a downpipe.

Protruding obstacles must not be placed in the inverts. This could obviously cause leaks.

### Movements in the material

Sheet metal absorbs both heat and cold. It heats up and cools down rapidly and readily, and therefore it can heat up and cool down to a temperature which differs greatly from that of the underlying material. This factor, combined with the coefficient of expansion of the sheet metal, can lead to great stresses between the roofing sheet and the underlying material. If attached incorrectly, movements caused by temperature changes can lead to fatigue in the sheet metal, with cracks forming as a result.

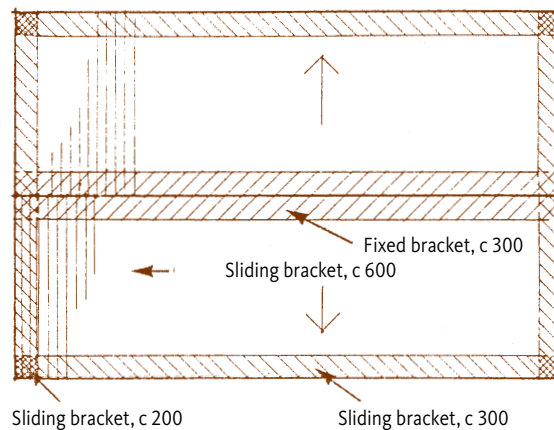

Attachment plan



Gutters are excellent as snow slide guards.

## DESIGN SOLUTIONS

To keep the number of potential risks to a minimum, it should be considered very carefully how many openings are really required. As regards their positioning, can an opening be placed in the facade beneath the roof overhang? Can a number of pipe flashings be combined to form a single one, or can they be collected together under a single cowling?

### Positioning of openings, pipe flashings, etc.

During planning and design, it can never hurt to look to the future by providing the roof for example with one or more conduits for future use. It may be appropriate to position these above the ascent shaft of the building.

It is possible that holes for cables, aeriels, etc. may subsequently need to be made in the roof covering. This can look unsightly and slipshod, and it is also a certain source of future problems in the form of leaks.

Satellite dishes, masts and cooling systems also often end up being put on the roofs of buildings as a kind of emergency solution. Each roof should be prepared with permanent attachment points – on chimneys, roof walkways etc – in order to avoid positioning objects poorly in a way which would adversely affect the maintenance and service life of the roof. This should then be documented in the “building folder” and also include instructions for operation and maintenance.

Openings can have a restricting effect on the movement of the sheet metal. Therefore, these should be placed as close to the fixed zone as possible.

### Positioning of access and safety facilities

Permanent attachment of access and safety facilities often locks the sheet metal in position and thereby

forms a fixed zone. It is possible to use mountings with properties which permit sheet metal movements in order to avoid the sheet metal being locked in this way.

### Positioning of hatches, chimneys and cowlings

Everything which has been said about pipe flashings and other openings and their positioning in relation to fixed zones applies also to roof hatches, chimneys and cowlings. These are often wider than the panels or strips and are generally placed parallel with the roof. They can cause formation of a “pocket” in which water, snow, ice and dirt can readily collect. One way of avoiding this – besides using chimney gutters – is to place the chimney (or hatch, or cowling) in the ridge. In addition, if the object is positioned so that one side of it is flush with the ridge, seaming is made easier.

Cowlings, pipe flashings or other objects on the roof should be separated from one another by no less than 400 mm so as not to impair qualitative sheet metal working. Standard panel and strip covering should have approximately 600 mm between the seams. If a tapered seam is to be made functional, the distance to the nearest seam joint must be no less than 200 mm.

### Gutters and snow slide guards

Gutters are excellent as snow slide guards and can be made considerably higher than the 150 mm usually recommended.

Hanging gutters are cheaper to fit and replace than other kind of guttering. If hanging gutters leak, the damage to the facade is not as extensive as if the other kind of guttering were to leak. Moreover, leaks in hanging gutters are also easier to locate.

A hanging gutter in combination with an eaves rail is, as a rule, more expensive to fit than other kind of gutter. If, on the other hand, no eaves rail is required, the hanging gutter is a cheaper option.

Nowadays, snow slide guards are available which are attached to the seams, they have the advantage that then follow the movements of the roofing sheet. In the case of long pitched roof areas, snow slide barriers may also be needed in the middle of the pitched roof area.



Warszawa Tower, Poland



Church in Helsinki, Finland

## ROOF SAFETY

Great demands are made of access and safety facilities for the regular care and expedient maintenance of roofs and installations. There are therefore a number of standards which cover functional requirements, testing methods, details, dimensions and components.

In the case of roof safety facilities, it is extremely important to observe how the attachments should be made. They must be able to withstand specific stresses, while at the same time they must be tight so as not to give the opportunity for leaks to occur. In addition, the material must not be weakened by corrosion. This latter point is of particular importance in respect of copper roofing. The retainer must be isolated from the sheet metal using a 2 mm lead sheet to prevent galvanic corrosion. The attachment device must be made of stainless steel.

Each roof should have requisite access routes and connecting routes to ridges, chimneys and fans. Steep roofs must be fitted with catwalks, ridge rails or other anchor points such as eye bolts or safety hooks to enable personnel to move sideways and on to which can be attached safety ropes.

Roof safety details designed for copper sheeting are made of copper or stainless steel.

Ridge rails including copper brackets, designed for copper roofs – must all be made from the same material so that galvanic corrosion is avoided which would otherwise occur when metals which are “less noble” are used.

Stainless steel is recommended for through fasteners designed for load-bearing structures.

## Roof safety factors

- » The roof requires continuous inspection, irrespective of its weatherproofing layer.
- » Installations and arrangements on roofs must be accessible for servicing and maintenance.
- » Falling – snow and ice can result in injury, and it is therefore often necessary to clear snow.
- » Roofs are designed to be able to withstand a certain snow load. If this is exceeded, the roof must be cleared of snow.
- » It may be necessary to have access routes for fan rooms and lift machine rooms.
- » In certain cases, it may be necessary to route an emergency fire escape to an emergency balcony at roof level via a roof and wall ladder mounted on the outside of the building.
- » There is a demand for access to chimneys which contain ducts which have to be cleaned according to regulations.
- » Permanent access routes may also be required for installations other than those specified in the regulations, such as roof-mounted radio and TV aerials, fans, heat exchangers and solar panels, which require regular inspection and maintenance.



Copper ridge rail.

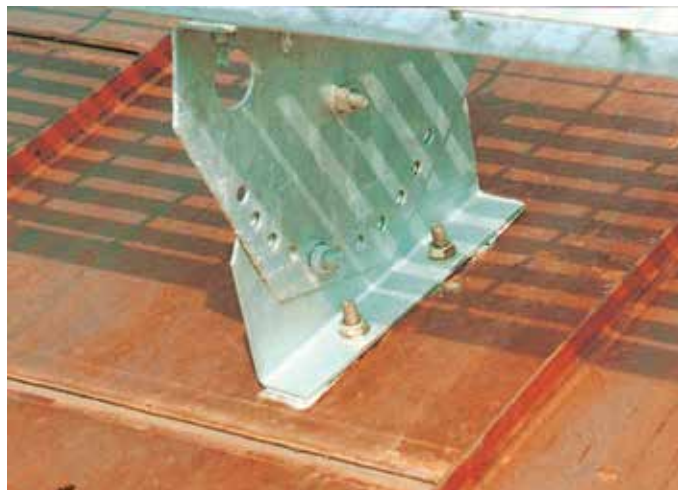

Attachment of roof safety facilities using a bolt made of stainless steel and isolated using a lead sheet.

# Roof covering principles



Traditional sheet-covering.



Strip-covering.

Copper has been easy to shape in order to comply with the building styles and architectures of various ages. Before rolling mills were invented, the sheet metal was beaten by hand. Of course, this method did not permit sheet metal to be produced in any large sizes. During the latter half of the 18th Century, different types of rolling method started to appear. However, beaten sheet metal was still the norm until well into the 19th Century.

The technique of joining together sheet metal by means of seaming is also very old. Copper roofs which were seamed during the late 17th Century are still in existence today: the roof on Hildersheim Cathedral is one example of this. However, despite the introduction of rolling mills, the sheet format was still restricted for a long time. The beaten copper sheeting was as a rule sized 450 x 950 mm or 450 x 570 mm.

The panel size increased over time, and a number of specific standard formats have since been developed: 610 x 914 mm, 914 x 1,219 mm, 1,000 x 2,000 mm. In the case of strips, strips 610 mm, 670 mm and 1,000 mm wide are dominant.

## TRADITIONAL SHEET COVERING

Covering roofs with sheet seamed together is known as traditional covering. The seams are known as standing seams and cross-welts.

Traditional sheet covering has a long history and was practised with the beaten sheet metal of the olden days. Today, traditional covering is used primarily on buildings where the designer wants to give the roof character, or when original architecture is to be retained and managed. Cross-joints not only create an attractive pattern, but they are also used for reinforcement which can be of benefit in the case of roofs exposed to the wind. Copper sheeting is always double seamed for reasons of strength, irrespective of the degree of slope of the roof. Many old European buildings with a cultural history have panel covered copper roofs.

Panel covering is often used for extensions and repairs to these old buildings.

This sheeting is prefabricated and often jointed at specific lengths in sheet-metal shops before being delivered to the building site.

## STRIP COVERING

Nowadays, copper is generally manufactured and supplied in strips. These can be cut into panels of any length. It is most common for the copper covering to be manufactured in long strips running from the ridge to the eaves. These strips are joined together using double standing seams.

Strip covering can normally be used on all types of roof. In the case of strip covering, the lengths are restricted by the need for movement joints (see the section entitled Movements and movement joints, on page 63 in the chapter entitled The climatic shell of the building). In the case of seamed roofs, the slope of the roof should ideally be greater than 1:10 (5.7°). In the case of full-length strips and when the roof is drained via external guttering, and where there are no obstacles in the form of roof hatches or pipe flashings, a roof slope of as little as 1:16 (3.6°) may be sufficient. The standard strip width is 610 mm; and this results in a spacing of 600 mm between the seams.

Strip covering is often slightly more advantageous price-wise when compared with panel covering due to the fact that as a rule it is easier to lay.

## PROFILED COPPER

Profiled copper is mainly connected together by means of lap joints. Profiled sheeting is attached to the structural elements by means of screws. Profiled copper is available in many shapes and lengths. Specially developed profile systems for copper roofing have become more and more common as roofing materials for both private and public buildings. This system permits a more or less unlimited panel length as the attachments permit movements in the material. Restrictions to the length are instead more common on account of transport handling factors. This system can be used on roof slopes of down to approximately 3°.

## SHINGLES

Coverings using small prefabricated copper panels are known as shingles. This method goes back a long way: some of these coverings were originally made with single lock welts. If one lock welt is used both horizontally and vertically, a single lock welted plain cover is formed. These seams can also be placed diagonally.

The covering can be laid both horizontally, vertically and diagonally. This method is used mostly for facades.

The single joint means that a roof slope of no less than 35° is required so that the roof is made sufficiently tight.

## SEAMING USING PROFILES OR BATTEN ROLLS

### Implementation:

The seam can be accentuated by means of increased height and width. The simplest way in which to increase the width is to fold a cover strip around the edges, which are bent up and folded out. For improved stability, the seam can be provided with a reinforcing angular plate element. Another way is to build up the seam around a strip of wood. If this strip is triangular or semi-circular in shape, an ordinary standing seam is formed, possibly on its side.

Seaming using strips with a square profile can be carried out in a number of ways. What is known as the German method means that plates are fixed at the upper side of the strip and attached to the sheeting, and then a cover strip made of metal is put on and seamed together using mounting plates and sheeting.

### Use:

The simplest type of widened seam is not very tight and must not be used for angles of slope of less than 25°. Wooden strips normally mean that the seam height increases, and this makes it about as tight as a single standing seam. It is difficult however to make connections with ridges or roof overhangs if a high degree of tightness is required. Here, soldering or welding may be necessary.

Strips can be seamed on both roofs and facades. It is always possible to place these along the line of the slope. If the seam is to be placed diagonally or horizontally, it has to be turned so that no water is able to penetrate. This can be done using a triangular or semicircular strip.



Examples of standing seam.



The sides of the sheet metal which are bent up are seamed together using a cover plate.



Examples of batten roll.



# Substrates

Flat sheet/strips, or smooth sheet as it is also known, is a thin material which requires a stable, fixed underlay. The quality of the copper used for roof coverings and wall claddings is a soft, very flexible material which makes seaming simple and straightforward. Unlike troughed sheet, flat sheet is unable to bear loads, which is why the foundation must be designed with a strength which compensates for this. The requirement for strength must also cover details and connections. Moreover, it is important for the support to be flat, as uneven areas can easily be seen in the finished covering or cladding.



When designing details and connections to be attached to other materials, all the working is done manually. A stable substrate is required.



It is important for the substrate to be flat.

Clout nails which have not been driven in correctly can creep up out of the timber over time. This is something which may be difficult to predict and prevent, but it is related to the nature of the substrate, moisture conditions, thermal movements and nail size.

## DIFFERENT TYPES OF SUBSTRATES

Seamed copper sheeting can basically be laid on all fixed substrates. The most common of these are wooden panelling or plywood, covered with bitumen felt. Lightweight concrete can be used. However, the copper sheeting must not be laid directly onto the concrete. In the case of ridges, walls, facade decorations and windows, the mortar screed is enough of a foundation. Hard mineral wool can be used under certain conditions. Attachments in concrete are labour-intensive as drilling and plugging are required. The same is also true for walls made of brick or calcareous sandstone.

When it comes to wall claddings, the need for fixed, firm foundation covering is not as significant as when laying roofs. The need for protection against condensation cannot be disregarded, but this does, of course, depend rather on the shape and aeration of the structure.

## BITUMEN FELT

Given the problems which can occur in the event of unevenness in the substrates, discussions have been in progress over the last few years regarding how best to attach bitumen felt beneath sheet metal. At present, only clout nails are recommended for attachment. Nails should always be hammered in at a concealed overlap. This will almost completely avoid the risk of the heads of the nails being pushed up into the sheet metal.

Bitumen felt is laid with its sections parallel or at right angles to the pitched roof area. The joints must be created with a minimum overlap of 80 mm, and the joints must always be sealed if the sections run in the same direction as the pitched roof area. The joints, if the slope of the roof is less than 1:3, must always be sealed, irrespective of how the sections are laid.

## UNDERLAY OF TONGUED AND GROOVED WOODEN PANELLING OR PLYWOOD

It is important for a substrate made of wood to be of the relevant thickness, given the need for fixings, and in order to achieve a sufficiently rigid foundation for seaming. The thickness depends on the purlin spacing, but experience has also shown that panel thicknesses as shown in the adjacent table are required for roof coverings using flat sheet.

SUBSTRATE THICKNESS, mm		
Material	Roof	Wall
Plywood	19	16
Tongued and grooved board	23	20

Recommended thicknesses for wooden supports at 1.2 m support spacing.

Boards must not be joined right through over the same support: however, two boards abreast of one another may be joined like this. Between supports, no more than every third board should be joined. If timber tongued and grooved at the ends is used, every other board can be joined between supports. Panels must be fixed using hot-dip galvanised nails.

If plywood is used instead of panels as a support, the thickness must be adjusted so that the underlay is rigid enough in order to seam sheet metal against it. It must also be able to provide sufficient security for brackets. Therefore, the minimum thickness should be 19 mm at 1.2 m support spacing.

General recommendations for brackets and fasteners assume that the substrates is made of wooden paneling, with thicknesses as per the table.

Plywood panels must be fixed using hot-dip galvanised screws or annular ring shanked nails. The recommended space between centres and space between rows can be seen in the table entitled "Fixing of plywood panels on roof".

In the case of wall cladding using flat copper, sheathing is used with tongued and grooved board or plywood in the same way as for roof coverings. Therefore, the

### FIXING OF PLYWOOD PANELS ON ROOF, mm

Space between centres – for nails or screws				Space between rows – for nails or screws
From edge	In edge zone	In edge	In inner row	
Same as panel thickness	< 100	< 150	< 150	< 1,200

thicknesses should be the same, but 20 mm wooden panelling or 16 mm plywood may be used at a joist spacing of 600 mm.

### Chimney gutters – slope behind obstacles

Chimney gutters should be provided in the case of all obstacles where there is a risk of water pooling. From the point of view of maintenance, a chimney gutter should be installed for all obstacles present. Framing, sheathing or plywood is often required as a substrate for the sheet metal. In the case of small obstacles, the chimney gutter can be installed directly in the sheet metal.

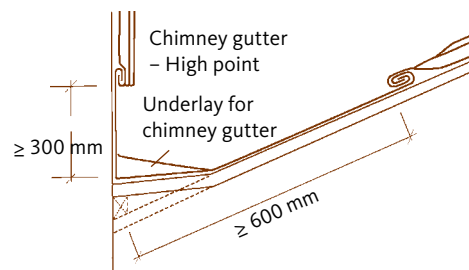

Supplementary foundations are sometimes needed in the case of chimney gutters.

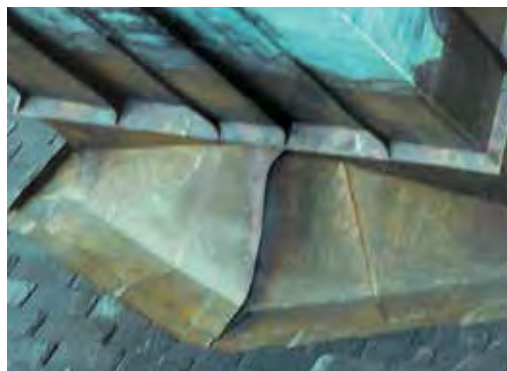

The chimney gutter ensures that no water pools behind the obstacle.

## SUPPORT AT DETAILS

Supplementary substrates for sheet metal flashings are often required at details, connections, etc. Their design is dependent upon the fixing method and the design of the details. Ridges and similar obstacles must also be sloped so as to counteract standing water.

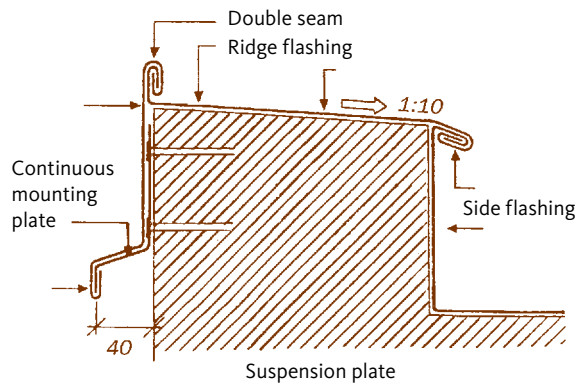

Ridges must have a fixed support for the sheet metal flashing to be effective. It is important to attach the sheet metal, and also to provide a slope so that the water can run off the ridge. The ridge slope should be no less than 1:10.

Wooden gutter frames are used for box gutters, gutters and recessed valleys. Normally, these are made of impregnated timber, but this is not necessary if the design permits good ventilation of the structure. A support (frame) is required so that the cross-joints in the gutter plate can be connected in a satisfactory manner.

In the case of box gutters and recessed valleys, the frame should be made of tongued and grooved timber of a minimum of 30 mm. These gutters are made with double "floors", of which the upper one slopes.

It is necessary to design the gutter support for each individual case, working on the basis of the anticipated load, gutter dimensions. Valleys must always be supplemented with a high-quality weatherproofing layer. Copper gutters are always manufactured with a wooden frame. The gutter frame is normally supplemented with a metal reinforcement in the form of a bracket hook or a traditional gutter hook. It may also be necessary to reinforce the support in order to ensure that the hook and frame are mounted sufficiently well.

This must be taken into account both during planning and when designing details. In the case of long, steep pitched roof areas, it may be wise, for safety, to attach the hooks using through screws, as well as a steel angle on the underside.

## Support for window edge flashings and mouldings

There are three main attachment methods in the case of overhangs:

- » wired brackets (in brickwork)
- » mounting plates, or
- » continuous mounting plates

In all these cases, there must be a substrate which permits effective fixing. Sometimes, window edge flashings are subject to great stresses, such as when the windows are cleaned. This makes demands of the support: it has to be sufficiently stable so as not to allow the flashing to be forced downwards when a load is applied to it.

Support which permit the fixing of flashings and mouldings include:

- » concrete
- » solid brick
- » wood

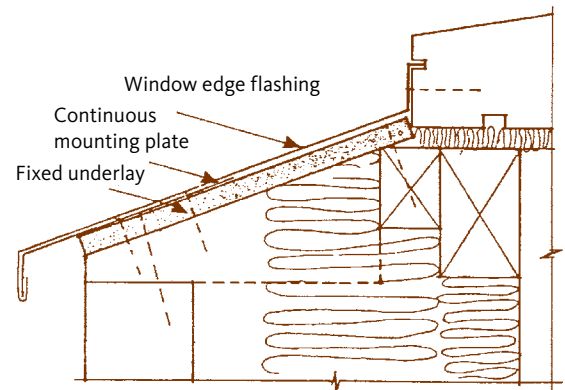

Attaching a window edge flashing using a mounting plate requires substrate in which nails or screws can be used.

In the case of window edge flashings – irrespective of whether the building is new, being extended or being converted – the substrate will in many cases consist of perforated bricks or thick mortar screeds. In the case of perforated bricks, for example, the attachment points may end up right in the middle of a perforation; then when the flashing is stressed, the mortar and plug may work loose and come out. If, on the other hand, the fixing points end up between perforations, there is a risk of the brick breaking. The best place for the fixing is in the vertical mortar, but at times this may be difficult to locate.

Lime cement mortar and cement mortar are stronger than lime mortar. The course directly beneath the flashing should ideally be made of solid brick. In the case of thick mortar screeds, the fasteners and plugs may scarcely reach the brick, thereby resulting in a weak fixing. In the case of rendered overhangs or facade mouldings, both the fasteners and the plugs must be seated firmly in the structure. The fixing will be far too weak if they are seated in the render alone.

Window edge flashings or facade mouldings attached only to render on insulation, where there is no mortar screed or other fixed substrates, normally have to be attached to the render surface using wired brackets. This method presupposes the use of facade insulation where the chamfered section is also reinforced with mesh. In this case, it is not possible to connect seams, which means that the facade mouldings may be uneven.

### Support using profile copper

Profiled copper, as well as most types of cassettes, are more rigid than flat sheet on account of their design. It is best to fix profiled sheeting on roofs or walls to battens or beams made of wood. This is also true for facade-matched cassettes. This means that an absolutely flat surface is not required in respect of bearing strength. However, it is important for the substrate to be sufficiently even and flat to ensure that the surface of the sheet metal does not become uneven or dented.

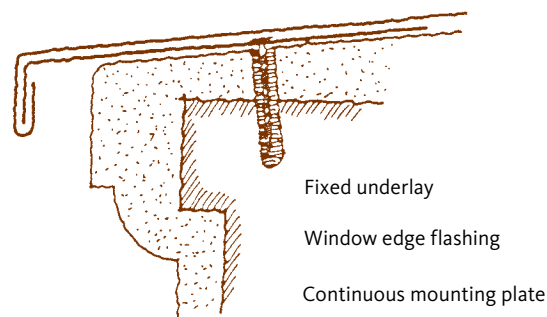

The fastener and plug must be seated firmly in the brick in the case of rendered overhangs.

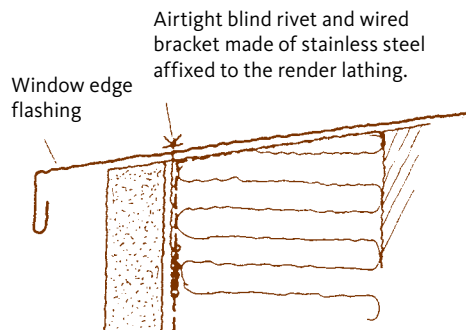

Fixing of a window edge flashing at a facade, with render on insulation. This flashing is susceptible to stresses, and therefore it should be restricted to lengths at which no joints need to be made, or at which joints are created as ends with upper seams.

# Designing the facade

## DESIGN

The facade can be said to be the public face of the building, the aspect of it which clearly and immediately signals its existence. This is what we use to determine the *raison d'être* of a building – quickly, unconditionally and beyond all doubt.

The facade is also the part of the building which gives it its character, and this is why a lot of care and hard work has always gone into creating the perfect facade. Decoration and ornamentation were common once upon a time. Many really ancient buildings offer examples of fantastic friezes, mouldings, pilasters, mascarons and bay windows.

Many of us may perhaps view metal-clad facades as a relatively modern phenomenon. However, there are many examples of beautiful facades of this type from as far back as the 18<sup>th</sup> Century. At that time, sheet dimensions were smaller than they are today, and as a rule the sheets were nailed directly to the base and overlapped. Smaller sections in particular, such as bay windows, were plated in this way.



Nordic Brown Light office building in Oslo, Norway.

The surface finish of the building facade has two tasks: to protect the building and to act as its face to the outside world. It must have a durable, weatherproof sealing layer; that is to say, a surface which protects it against the wind and weather and is simple to maintain. If the overall aim is to ensure energy efficiency, the outermost layer of the facade – the facade panel – must be combined with an effective, functional insulating material.

During the planning and design phase, careful attention should be paid to planning everything which is to be attached, including anything which may have to be attached on the facade: advertising signs, clocks, fire escapes, flagpoles, etc. All of these items require a durable, strong base if they are to remain in position in the long term.

Most facades are fitted with mouldings and flashings of some form or another. The base is always crucial to how securely these are attached, and thus to how stable they are. Even what seem to be simple details often need a stable, firm foundation in order to remain correctly in position. If corner plaster beads, suspension plates and the like are to be fitted using concealed fasteners, they need a base which does its job. A good, firm base always provides precisely the conditions needed for the sheet-metal worker to do his job to the best of his abilities.

Corrosion resistant proof joints should be used whenever any kind of sheet metal is to be attached. When it comes to fitting profiled sheeting, self-tapping screws are the most viable option. These screws should be put in the bottom of the profile.

Cassettes are mostly overlapped. The fasteners are thus visible, as is the case with profiled sheeting. There are also systems which include mouldings and similar which permit the fasteners to be concealed. The design of the overlap may vary depending on the method of attachment used. It is recommended that grommets made of chloroprene rubber or ethylene propylene diene rubber (EPDM) be used in order to guarantee tight fastenings.



Nordahl Grieg school in Norway.

## SEAMED COPPER SHEETING

Wall cladding using flat copper sheeting is applied in the same way as roof covering; that is to say, using standing seams and cross-joints. Under normal conditions, double lock welts are always used. Only on narrow surfaces or in highly protected areas can single lock welts be recommended. These are attached in the same way as on roofs, i.e. using clips. If a sheet size is used which permits a greater width between the standing seams, the cross-joints can also be clipped.

As a rule, cladding is connected to a drop apron or moulding, and its lower edge is arranged so that drips of water do not run down onto the lower surface sheet. Cladding can also be connected to a cover flashing which is fitted from beneath a lower roof surface.

At its upper edge, the cladding is either connected to a roof covering or ridge flashing by means of seaming, or to a moulding, flashing or similar by means of an overhang.

## CASSETTES

Cassettes made of copper or copper alloys are now being used to a greater and greater extent. Designs of these are often custom made and are normally drawn

up in consultation between the architect and the sheet supplier/cassettes manufacturer prior to construction of each specific detail.

Cassettes mounted vertically remain dark brown to black as a rule. Only where the surface is exposed to moisture does a green patina eventually form.

Compared with non-alloyed copper cassettes, cassettes made of brass – tombac – maintains for longer the bronze colour than non alloyed copper.

## SHINGELS

Shingels is an old method which was originally implemented using single lock welts. If one of the welts is used both horizontally and vertically, a single-seam plain cover is formed. The welts can also be positioned diagonally.

Shingels most closely resembles small cassettes. The size of the shingel can vary considerably. When attaching clips and ring-shanked nails of copper are used.

The joining principle demands steeply sloping roofs. A slope of no less than 35° is required if the roof is to remain watertight to a satisfactory extent.



Flat sheeting is a good material for curved surfaces. Planetarium in Copenhagen, Denmark.

## SUBSTRATE FACADE

The seamed copper-clad wall with facade sheet in the form of strips or sheets requires a firm substrate, as does traditional copper roof, and this substrate must be able to withstand dressing of the sheet and permit clips to be used for fixing purposes. The substrate should be made of 22 mm tongued and grooved board or 19 mm plywood. In the case of troughed sheeting, panels and cassettes, the technical requirements for the substrate are more or less the same.

Irrespective of whether the building is new or being renovated, the underlay must be level. Any warping at the fixing points will gradually become apparent even to the untrained eye, particularly in regard of smooth surfaces. Nowadays, adjustable metal spacers are available which permit even old, uneven surfaces to be fitted simply and so that they are level.

The attachment methods used for troughed sheeting, panels and cassettes vary. Profile ends are screwed on from the outside using visible fasteners and directly into metal spacers on the load-bearing structure. As a rule, panel fasteners are completely invisible and fitted in spacers, while cassettes are often suspended by means of specially designed concealed brackets.

## MATERIAL RIGIDITY

The only thing which reinforces a seamed wall cladding to any extent is the seams themselves. As seams can easily be bent, shaped and buckled, the seaming method is recommended for use for curved wall surfaces, either concave or convex.

One great advantage of profiled sheeting is its rigidity in the direction of the profile. It is possible to attain a considerable span, depending on the height of the profile. There are limits to the rigidity of profiled sheeting across the direction of the profile. Too great a distance between the attachment points across the profile can result in undesirable movements and noise.

As is the case with profiled sheeting, panels are rigid only along their length. The maximum panel width is dependent on the rigidity and thickness of the material.

The hardness and thickness of the material are also crucial to the size of plain coffer. Moulded shapes or cross-joints provide added rigidity and can result in bent sheeting if the material is too thin.



Copper cassette facade on office building in Skellefteå, Sweden.

RECOMMENDED MATERIAL THICKNESS	
Copper sheet thickness mm	Width of cassettes mm
1.0	200
1.0	300
1.0	400
1.0	500
1.5 – 2.0	600
1.5 – 2.0	700
1.5 – 2.0	800
1.5 – 2.0	900
1.5 – 2.0	1,000
1.5 – 2.0	1,100

## PROTECTION AGAINST DAMAGE

The results of mechanical damage really do spoil the overall impression. Such damage is most often found at ground level.

Collision damage can be avoided by fitting a higher base or a protective raised edge. If the design does not permit such solutions to be implemented, the lower sheet should be readily replaceable. Collision damage can commonly occur at loading platforms and the like. Pay attention to vehicle heights and narrow spaces. Protect the sheeting, or make it easy to replace.

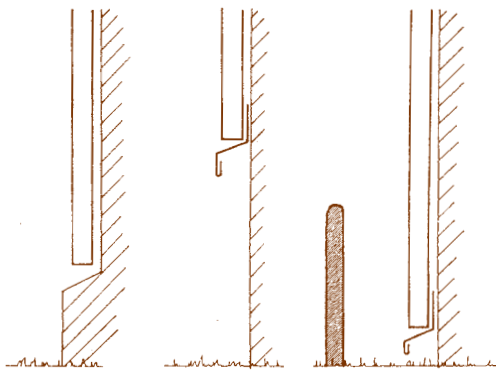

High or projecting bases, or raised edges – these will all provide protection against collision damage.

## A CLEAN FACADE

All open surfaces gather dirt. The advantage of smooth copper sheet in this respect is that much of the dirt is “washed” away by rain. Porous surfaces such as brick, plaster, wood, embossed metal surfaces or profiled sheeting fitted horizontally are not flushed clean in the same way.

Irrespective of the structure of the surface, it is necessary to take steps to avoid exposing certain facade sections to large, concentrated quantities of rainwater. In the slightly longer term, this can result in the facade looking patchy.

The amount of water to which facades are subjected when it rains or snows are greater at the bottom than at the top. In the case of high, unbroken facade cladding, very large amounts of water can come into contact with the lower sections of the facade. To prevent this from happening, smooth facades can be “broken up” by placing water-repellent mouldings along them at intervals. In the case of sheet metal facades, these are ideal for combining with the movement joints of the facade.

At the point where the upper and lower sections meet, rainwater should be drained off so as to prevent the risk of discoloration.

Rain marks can appear beneath roof overhangs, balconies and other large rain-repellent building details; that is to say, surfaces which are not flushed clean by rain as no rain comes into contact with them. In very polluted environments with a high level of atmospheric humidity, the surface layer at these “marked” sections are subject to more rapid disintegration than those which are regularly flushed by rainwater. Sections of this type should therefore be cleaned, even if other parts of the facade do not need to be washed.

## DAMP AND CONDENSATION

Damp and condensation can form on the inside of the facade (the reverse of the sheeting). Condensation, or the lack of it, may depend on how well the damp-proof course works and on how the facade is ventilated. The position of the building and its exposure to the wind and weather can also play their part.



In exposed areas, the wind pressure can drive water up between the overlaps of the sheets and the coffer if these are not sufficiently large. Profiled sheeting fitted horizontally must not be fitted using lap joints. This makes it easy for water to penetrate between the sheets, and as well as that, slots at eye level are not pleasing to the eye. Instead, splices should be created using pilasters or connection pieces. These should be provided with capillary breaks.

## MOVEMENTS

Sheeting moves in relation to the substrates, and this must be taken into account when fixing it in position. The following should be borne in mind: where and how will the movements be absorbed? Where must I position the movement joints? Do I need to use a special base, or perhaps reinforcements, to fix forged details such as overhangs, signs or flagpoles, and is there a risk that I might encroach upon the need of the sheet to move freely?

The extent of material movement also depends on the length of the sheets or panels. Long sheets may be easier to fit, perhaps using a limited number of joints. However, really long sheets can end up being both difficult and costly to handle. Even if the lightweight rafters are flexible, sheets which are too long can lead to the enlargement of the screw holes due to of thermal movements in the material.

The thermal movements in copper sheeting must be taken into account even when the copper is combined with other materials. Defective joints on plaster beads can easily lead to cracks forming in the plaster. Long facade mouldings in combination with plaster must be connected by means of seams. Overlaps can result in cracks forming and must therefore not be used as a jointing method in such cases.

Window frames with linings and flashings made of metal and which are “tensioned” in a facade made of brick can easily start to bulge outwards. A degree of movement which is sufficient for the purpose must be permitted.

## OPENINGS

Modifications made to a facade after the main constructional element has been completed never turn out particularly well, they usually destroy or distract from the overall impression of the facade. Generally, holes drilled into a facade to form cable entries or pipe are difficult to make look neat and tidy and to blend into the surrounding facade.

The same applies to ventilator grilles fitted post completion of the major part of the facade. It is always an excellent idea to consider all openings of this kind, both the obvious ones and any that might need to be included at a later date, at the planning and design stage. Ventilator grilles should be positioned in connection with other mouldings, such as with movement joints or drip mouldings, for example. If the ventilating equipment is not equipped for cooling at present, this may be required at some point in the future. If the facade can be prepared for additional ventilator grilles to be fitted, or if the grilles can be oversized so that they are sufficient for any future needs which may arise, this preparation work should be carried out at the planning and design stage.

The preparation of cable entries for any facade sections which may be used for displays, lighting or the like is also recommended.

## DETAILS

Flashings and mouldings for draining off water should have a slope of no less than 1:8 (7.5°). In the case of plastered facades or any other similar material, flashings should end no less than 40 mm beyond the facade. On the other hand, in the case of facades made of profiled sheeting, or any other water-repellent material, flashing should end as close to the facade as possible (10 mm) in order to prevent rain marks. In addition, they should be positioned no less than 100 mm behind the wall cladding. When fitted behind profiled sheeting, cassettes and similar, flashings must be provided with capillary breaks so that water cannot be forced upwards by the pressure of the wind.

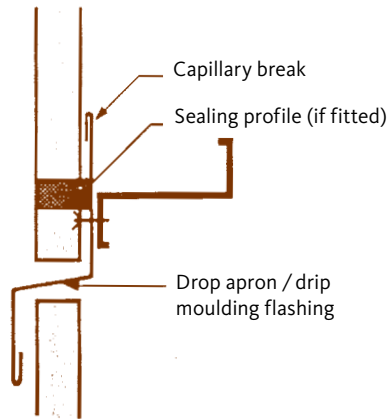

Drop aprons must be provided with capillary breaks.

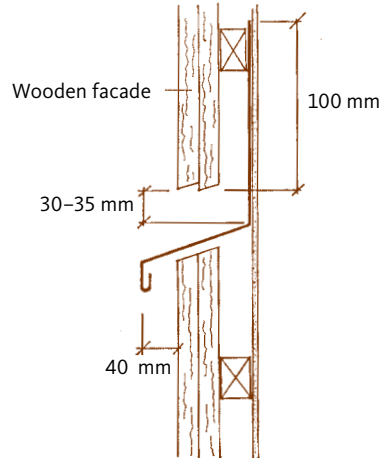

A slot of no less than 35 mm is essential for the maintenance painting of end grain.

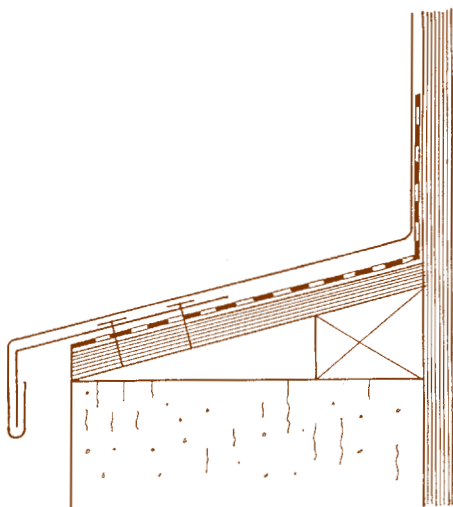

The base is important to the end result.

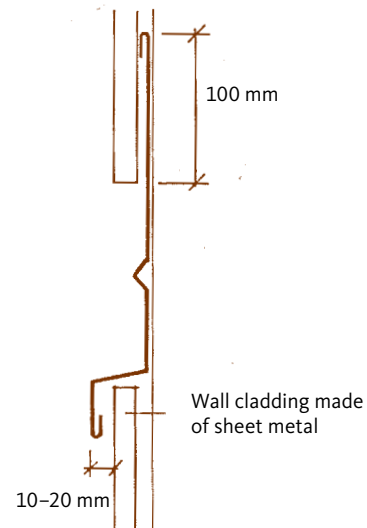

Reinforcement of a wide flashing.

- » Flashings, mouldings and plates must have a proper base and should be attached using mounting plates.
- » Blind riveting should be avoided.
- » Air gaps must not be too narrow.
- » Wide corner plaster beads and window frames can be reinforced by means of an additional joint.

# Roof drainage

## GENERAL

A complete roof drainage system is required, with correctly sized gutters and pipes, along with wells and overflows positioned correctly, for the roof to provide effective protection against rain, snow, sleet, etc.

It is no less important for the roof drainage system to be designed to withstand the formation of ice. As a rule, external cold gulleys are sufficient on steeply sloping and cold, ventilated roofs to maintain this function. Hot, non-ventilated roofs must have hot gulleys. Roofs which are flat or have a shallow slope – hot or cold – should be fitted with hot gulleys. It is not uncommon for combinations of various types of roof to be fitted on one and the same building, and this can sometimes make it difficult to define precisely where the boundary should go between hot and cold roofing. Therefore, it is expedient always to carry out extremely precise calculations for roof drainage systems, based strictly on each specific roof situation, in order to obtain an optimum technical solution.

The formation of ice in gutters and downpipes can often be avoided or dealt with by using heating cable. The basic reason as to why ice is forming should be clarified before any action is taken to counteract it.

The roof drainage system may be based on surface mounted gutters and downpipes or on recessed, built-in systems, or on a combination of these.

It should be borne in mind that it is not only the roof area to be drained which provides a point of reference for determining the diameter of gutters, downpipes and overflows. The tendency of the guttering to become blocked due to the accumulation of rubbish for example, also has to be taken into account.

Standards and sizing regulations for roof drainage systems do sometimes vary greatly between countries and regions. In this instance we would recommend that you check the national building standards and regulations governing this in the country in which the work is to be carried out.



Circular bending



There are many different types of prefabricated systems on the market.

## GUTTERS

Gutters and piping systems must meet the demands of EN612 and EN1462. In addition, gutters must be installed with a beaded front edge and a rear edge with an open cover.

There are many different types of prefabricated system on the market, such as semi-circular and rectangular gutters, lengths of between three and six metres are the most common. A large number of bespoke systems are available as well.

It is important for the guttering to be fitted in such a manner that its front edge is at least 8 mm lower than its rear edge. Gutter brackets and outlets must be seamed and soldered. Alternatively, it is possible to use prefabricated gutter brackets of the appropriate strength. The gutters must be provided with leakproof ends.

Gutter hooks may be made from 6 x 30 mm copper or 5 x 25 mm stainless steel section. At the front edge, the gutters are attached to the hook by means of a nut and bolt, and at the rear edge they are attached by means of clips made of 0.7 mm half-hard metal. Bolt ends are cut and riveted onto nuts. The distance between gutter hooks should not exceed 600 mm. In the case of gutters in exposed positions – where there is reason to believe that large amounts of snow will collect, for example – the gutter hooks must be fitted more closely together (400 mm, for example). The gutter must be fitted with a slope of no less than 5 mm/m. Guttering must never be fitted with a backward slope.

In the case of copper roofing, weatherproofing mats, canvas and similar, the gutter hooks must be turned down in recesses to the same level as the base and be covered by the weatherproofing. In the case of other roof coverings, the gutter hooks may be positioned above the base but beneath the bitumen felt, if this is fitted. Recesses are not required in the case of gutter hooks mounted vertically.

Where a timber base is used, no less than 150 mm of the length of the gutter hooks should be in contact with the timber. In the case of timber roof trusses, the gutter hooks should be attached using two 75 mm corrosion resistant screws, and 35 mm corrosion resistant screws are used to attach the gutter hooks to the roof boarding.

Where a lightweight concrete base or similar are used, no less than 300 mm of the length of the gutter hooks should be in contact with this, and they should be attached using three 6.0 x 80 special screws made of stainless steel which are designed for lightweight concrete. These should not be fitted less than 100 mm from the eaves.

Water runs off from the gutter via a water cup or flange cup. Holes are made at the flange cup at an edge made in the cup, where the opening must not be less than the drain area of the cup.

A sliding joint is made in the flange cup to permit movement due to expansion in the gutter material which are already fixed. The movement joints are positioned at the highest point between two outlets. In the case of rigid attachments, joints which absorb movement must be fitted when the length of the gutter is in excess of 10 m.

Gutters which cannot be fitted in a complete gutter slope should be fitted using field connections with an overlap of at least 100 mm or using special splice plates. In the case of rectangular gutters, joints are often effected by means of seaming or soldering. These joints must be rigid.

## PROTECTIVE FLASHINGS FOR GUTTERS

Protective flashings are joined by means of single lock welts or lock joints and fitted with the requisite ends. Continuous mounting plates are used to attach these.

## EDGE SHEETS

Roofs which terminate at a gutter should be provided with an edge sheet on the roof overhang. The edge sheet directs the water to the gutter and also prevents water and snow from building up behind it. The edge sheet should be made of 0.7 mm half-hard copper, and no less than 150 mm of its length should be in contact with the roof. It is jointed using single lock welts or with an overlap of no less than 100 mm. The length of the sheet should not exceed 2,000 mm. The edge sheet is attached to the base using annular ring shanked nails made of copper, zigzagged by approximately 150 mm. Wherever there is a risk of erosion corrosion, a wearing plate made of 0.7 mm half-hard copper can be fitted. This is jointed with an overlap and attached in such a way that it can be replaced easily.

## BOX GUTTERS

Frames must be made of at least 30 mm tongued and grooved board or equivalent. The gutters are created with a double bottom, the upper one sloping. Gutter hooks should be selected for each individual case. Box gutters are fitted with a slope of no less than 1:75.



A timber frame is used for gutters for copper coverings.

The front edge of the box gutter must be no less than 50 mm lower than the connecting seam between the roof coverings and gutter plates. Ends are seamed and soldered. It is important to ensure that the edge sheet is the same length as the gutter plate. 0.7 mm annealed metal should be used. The edge sheet is jointed by means of a single lock welt.

If there is a risk of erosion corrosion, a wearing plate should be added to this structure. This wearing plate is fitted in the same way as outlined in a previous description of guttering.

## GUTTERS

A timber frame is used for gutters for copper coverings. Here, the fixing of the bracket hooks is extremely important, and therefore the base may sometimes need to be reinforced so as to obtain good results. In the case of roofs with a long, steep slope, instead of reinforcing the base, it is possible instead to use bolts with brackets on the underside. The edge of the gutter should be no less than 150 mm high and have a minimum slope of 1:75. The gutter is attached to the roof covering by means of a double lock welt.



Example of protective flushings (gutters not yet installed).

## RECESSED VALLEYS

### Valley gutters

Valley gutters can be constructed using plates or strips. In either case, the gutter has to be made of 0.7 mm copper sheet, and the fold must be approximately 450 mm at either roof slope. The valley gutter has a double lock welt.

### Valley gutters – strips

In the case of gutter slopes of less than 10 m, the gutter may be made using strips with no cross-joints.

## EXTERNAL DOWNPIPES

Downpipes must meet the demands of EN612 and EN1462.

There are many different types of prefabricated system on the market, such as semi-circular and rectangular gutters, and lengths of between three and six metres are the most common. A number of bespoke systems are available as well.

Downpipes are attached using pipe union pieces, with a maximum distance of 2,000 mm (always use at least two pipe union pieces). Joining takes place using a sleeve or plug-in attachment with a conical end, particularly junction pieces or by means of seaming and soldering. Longitudinal joints must be attached using a single lock welt plus soldering, or a double lock welt. Damage caused by moisture can be prevented by turning longitudinal joints away from the facade if this is made of a moisture-absorbing material.

Downpipes should be fitted at a mutual distance of no more than 20 m (10 m gutter slope). How to install internal downpipes is not dealt with in this section due to the fact that it is normally considered to be part of heating, ventilation and sanitation work.

### Connections

When connecting the roof drainage system to rainwater pipes, it should be fitted with a strainer or some other kind of cleaning device appropriate for this purpose. This strainer should be easy to replace. Downpipes which are not connected to rainwater pipes must be fitted with rainwater shoes.

### Gutter drains to external downpipes

Water cups are fixed to the edge of the gutter using at least 1 mm twin-element wire made of stainless steel in accordance with EN10088-3-1.4436. The gutter drain is conical or cylindrical in shape and attached by means of seaming and soldering.

## ROOF OUTLETS TO INTERNAL DOWNPIPES

Roof outlets to internal downpipes are conical or semi-spherical in shape, hard soldered or welded, and with sea-able joints with gutter plates or flange plates. Joints to flange plates must be seamed and soldered, or welded. The joint must be rigid and the outlet fitted with a removable strainer.

### Overflows

In the case of internal roof drainage, it is important to plan installation of the overflows in positions where blockages may occur in the downpipes. Using more wells must not be allowed to replace the need for overflows.

Overflows should be of such a size that they are able to cope with three times the estimated quantity of water. They have to be connected to gutter plates by means of seaming and soldering, or welding.

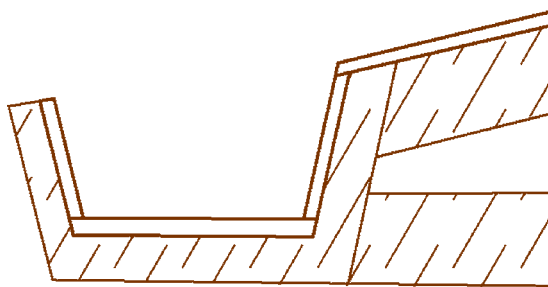

Box gutter

# Individual details

The following pages show the most frequent used details for copper sheets.

All occupational group and professions and their sub branches have developed their own technical terms and special expressions. This is also the case in the sheet metal business.

An architect or a building contractor, who is familiar with this type of expression, can much easier explain to a metal sheet worker how he wants a certain detail done.

## FREE EDGES



Beaded edge



Double bead

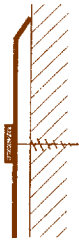

Face fixed flashing



Beaded edge, face fixed flashing angled sill

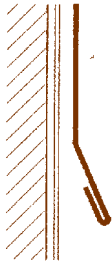

Sill



Sill

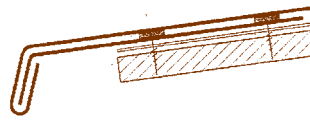

Traditional eaves detail

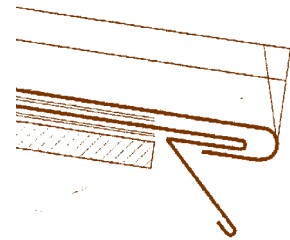

Long strip eaves detail

## JOINT DETAILS

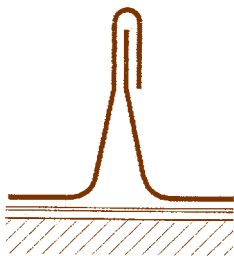

Single lock welt

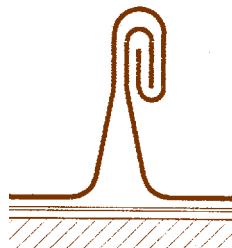

Double lock welt

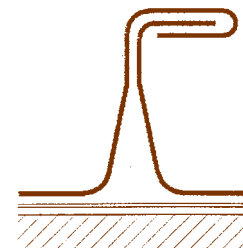

Angled seam

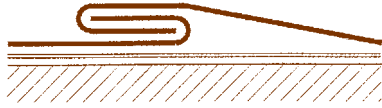

Single lock flattened welt



Double lock flattened welt

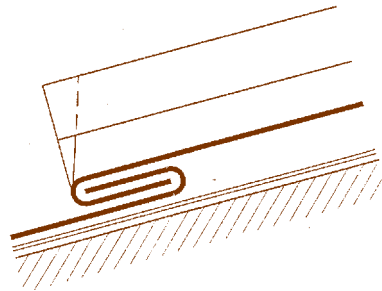

Horizontal Single Lock Welt

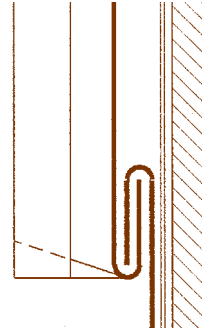

Vertical Single Lock Welt

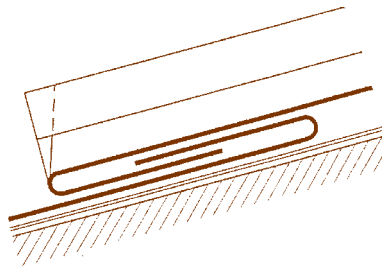

Single lock welt enlarged for expansion

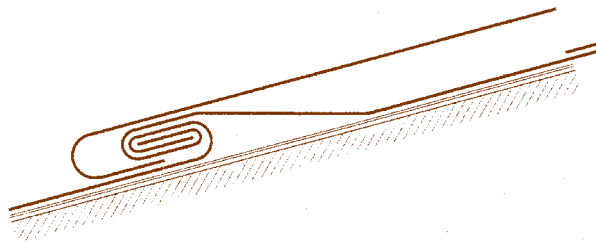

Double lock flattened welt and single lock welt enlarged for expansion

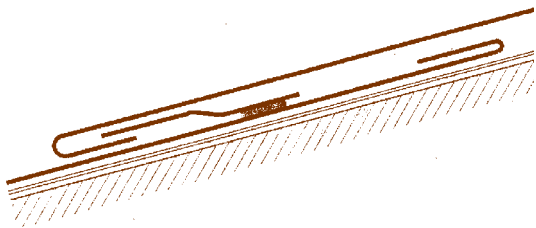

Single enlarged lock welt with fixing and capillary protection

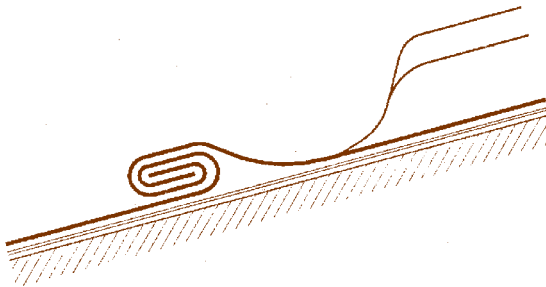

Double longitudinal seam



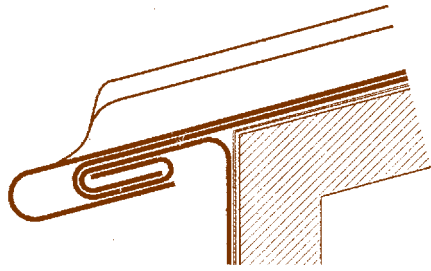

Single seam allowing expansion

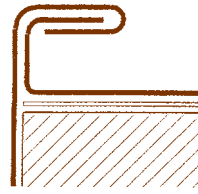

Angled seam verge



Double seam verge

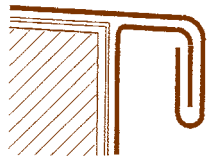

Single seam extended eaves drip

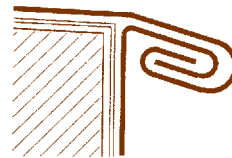

Double lock seam



Tube seam



Corner seam



Vertical fixed lock seam for facias



Lock seam with sealing strip



Ledge Connection With Sealing Strip



Overlap Soaker With Sealing Strip

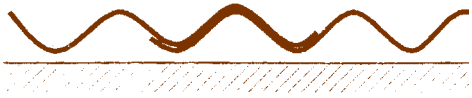

Lap joints



Lap joints



Lap joints



Lap joints

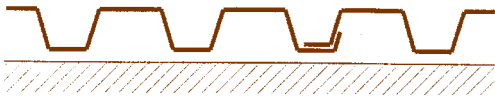

Lap joints

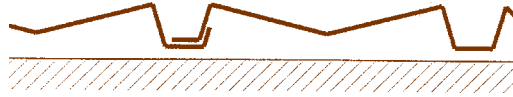

Lap joints

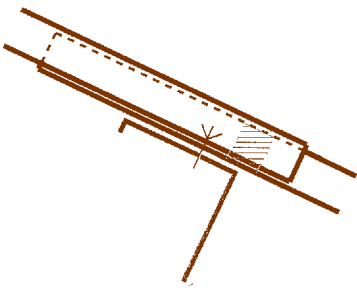

Fixed End lap

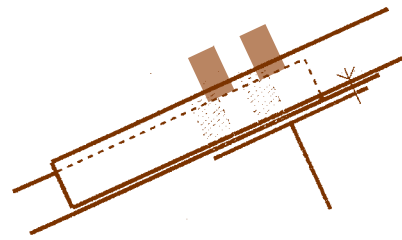

Expanding lap

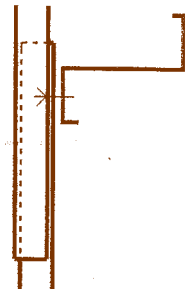

Fixed End Vertical Lap

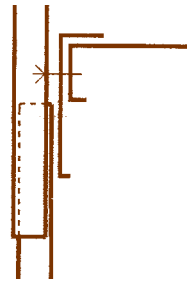

Expansion End Lap

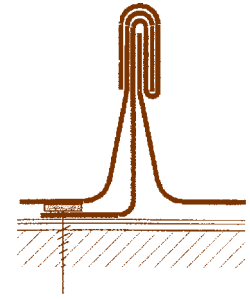

Standing Seam With Fixed Cleat

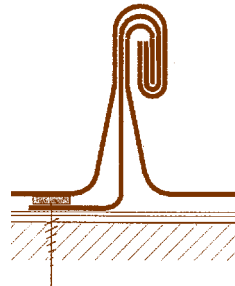

Standard Double Lock Standing Seam Joint

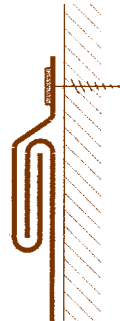

Continuous Single Lock Clip

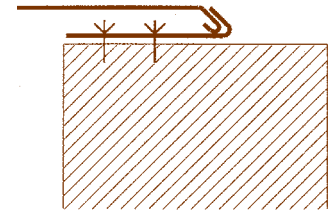

Lock Clip

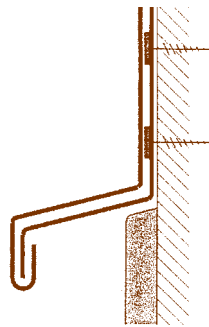

Sill Flashing With Stiffening Strip

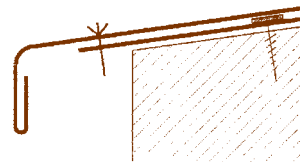

Copping Fixing

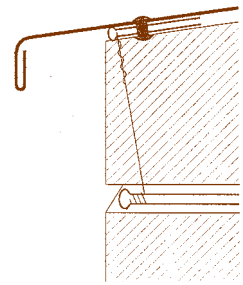

Rod Fixing

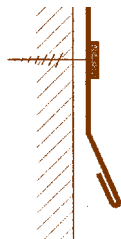

Visible Fixing

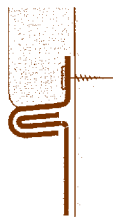

Plaster Edge With Hook Fixing

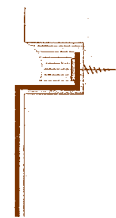

Hook In Joint

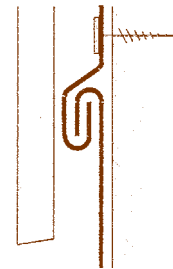

Hook Fixing Behind Facade Panel

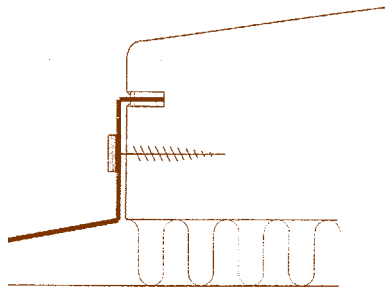

Hook To Window Frame

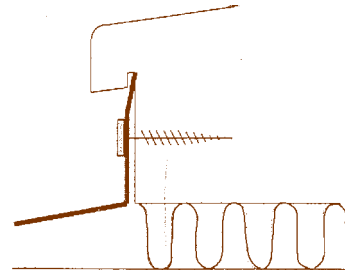

Connection To Window Frame

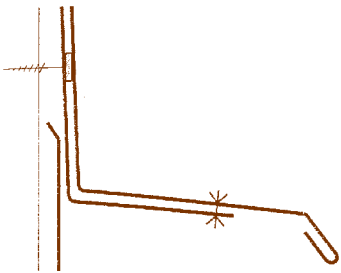

Cantilever Drip

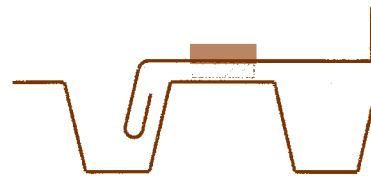

Cantilever Drip With Sealing Strip

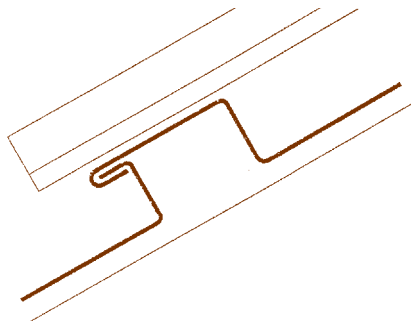

Junction Roofing Tile To Valley Gutter

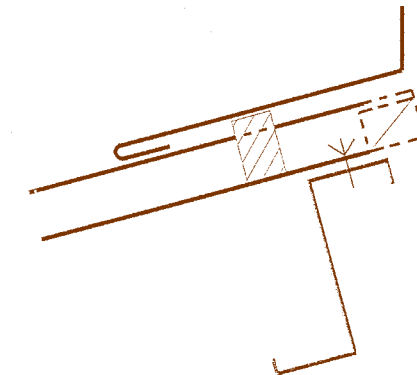

Cantilever Drip With Profile Filler

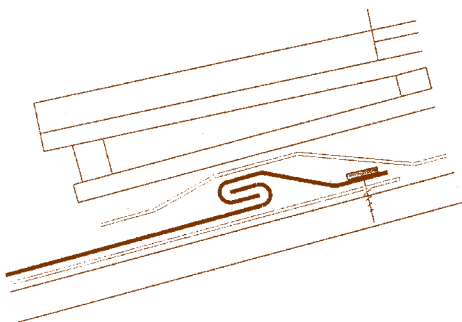

Junction Roofing Tile To Valley Gutter

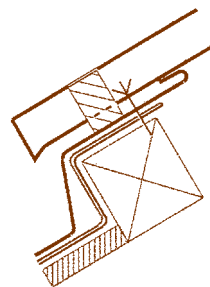

Valley Gutter With Profile Filler

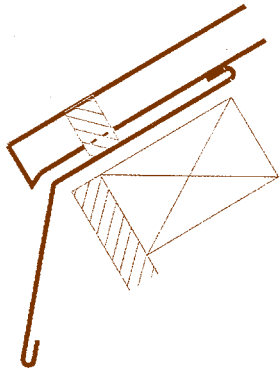

Ending Profiled Copper To Fascia Board

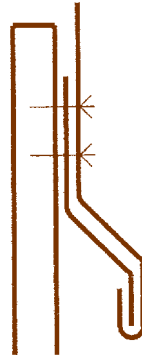

Ledge Angled Drip Over Profile Copper

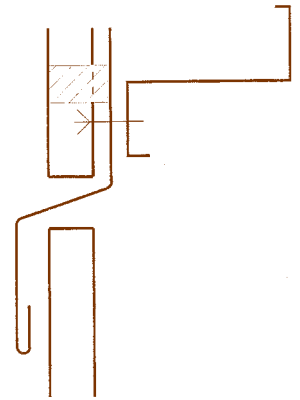

Ledge Over Profiled Copper

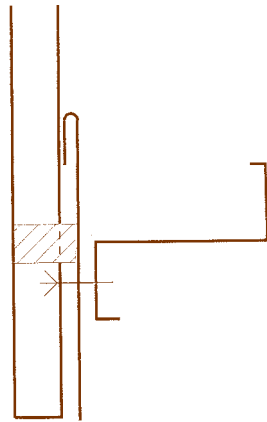

Detail of Capillary Hook Behind Profiled Copper

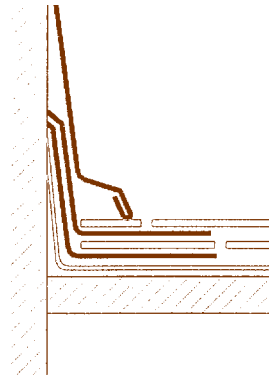

Verge Abutment



Junction Slate To Sheet

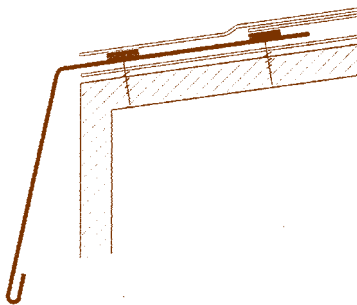

Papp Trim

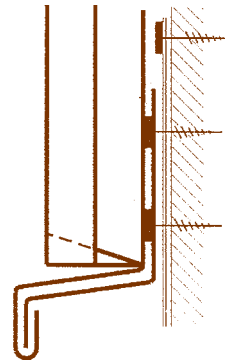

Ending of Copper Sheeting Over Felt



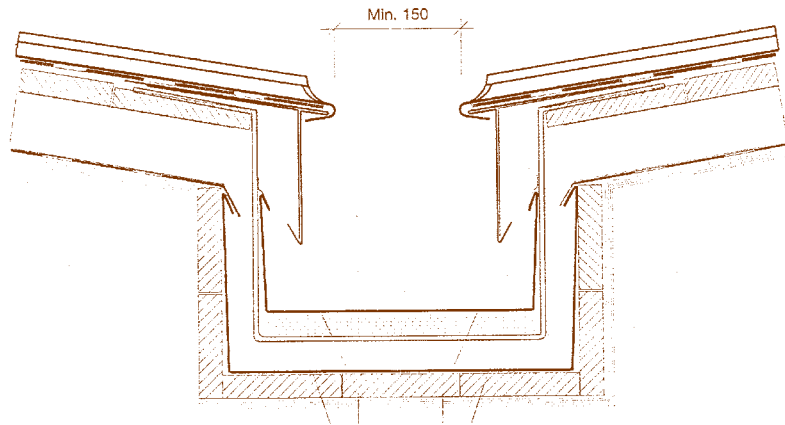

Valley Gutter

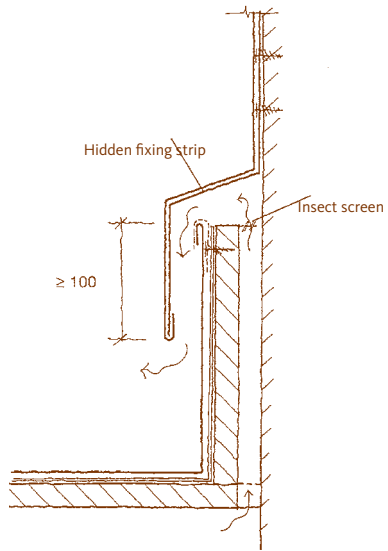

Ventilated Verge Abutment

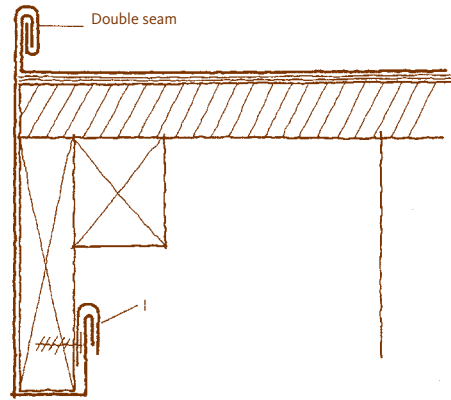

Verge Detail/Barge Board

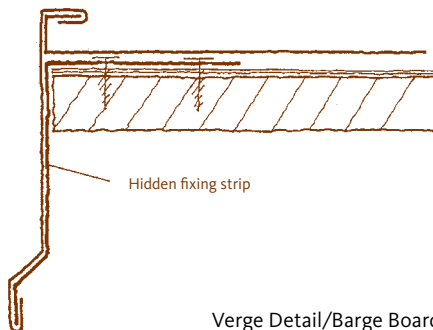

Verge Detail/Barge Board

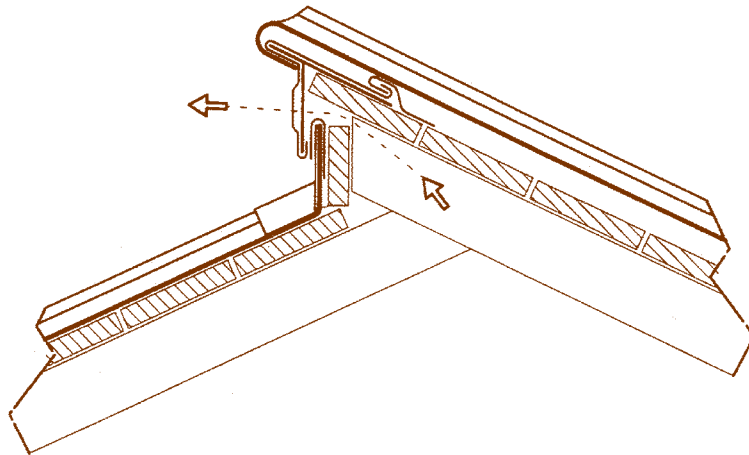

Details of Ridge Ventilation

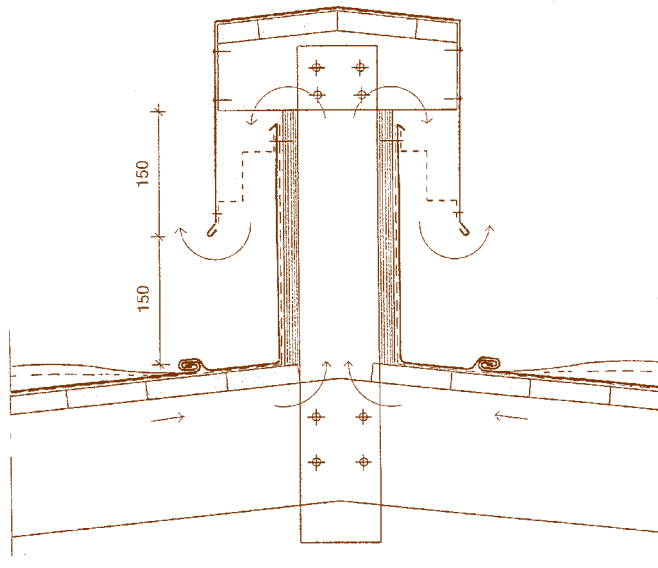

Details of Ridge Ventilation

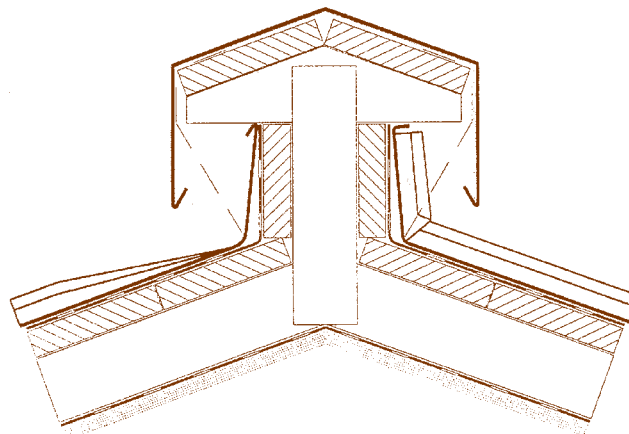

Details of Ridge Ventilation





Office Building,  
Stockholm, Sweden

# Sheet metal working and forming

# Sheet metal working and forming

## COPPER SMITHS

Copper smiths carry out the various elements of sheet-metal work required within the scope of roof and facade cladding using sheet metal in the form of flat sheet, profiled sheeting, coffers and panels. This kind of work also includes trimming; that is encasements around chimneys, ventilator cowlings, blowpipes etc. It also includes all the sheet-metal work involved with the manufacture and installation of roofing and facade details such as window edge flashings, ridge flashings, facade mouldings, water drainage mouldings and drainage systems.

## FLAT COPPER SHEETING

Flat copper sheeting (flat sheet) is supplied either cut to size or as strips or sheets in rolls for working and application in sheet-metal shops. It can be supplied in a large number of different sizes and thicknesses and with varying kinds of surface treatment.

In the case of roof covering, a quality is used which is designed for working directly on the building site. A harder quality is used for window edge flashings, mouldings, coffers and panels as this gives a smooth and very flat end-product.

The flat sheet is sheared, preseamed and worked in the workshop or on the building site until it is of the correct size and shape. Encasements for details such as chimneys, ventilator cowlings and dormer windows are made by sheet-metal workers directly on the building site.

Mouldings and flashings are made out of flat sheet to fit each individual building component. Coffers and panels are often manufactured at the sheet-metal works. A small range of standard products are also available directly from wholesalers and suppliers of sheet metal.



Encasement for a belfry.

## PRE-FABRICATION

This term covers a number of sheet-metal products, details and accessories manufactured industrially: rolled, dressed or bent. Profiled sheeting, coffers, panels, gutters and downpipes are normally pre-fabricated.



Handmade copper ornament.

## FITTING

Profiled sheeting, cassettes and panels are shaped after manufacture and are, as a rule, ready to be fitted with no further work necessary at the building site. These products are standardised in respect of their accessories and details.

## MACHINE PROCESSING IN THE SHEET-METAL SHOP

The most common processing methods for flat sheet for construction purposes are as follows:

- » shearing
- » press braking
- » rolling
- » seam dressing
- » seaming

### SHEARING

Cut-to-size sheeting is sheared to the required dimension using power shears.

Modern power shears can be programmed so that the sheet is sheared to a specific width or a certain number of times.

### PRESS BRAKE

The sheet is bent into the desired shape in a press brake machine. Rear-end guide displacement and the degree of bending are programmed into this machine. The guides in the press brake machine can be replaced with specially shaped upper guides, lower guides and curving guides which can be used for press braking complex details such as mouldings, cassettes and panels.



Leveling and cut-to size machine.

## CURVING AND BENDING PROFILED SHEETING

Profiled sheeting can be shaped into arches, corner elements etc. There are specific standard designs.

Profiled sheeting can also be shaped on the building site, depending on the profile height and material. The sheet is curved over a slightly convex or concave surface after having been fixed properly to the roof base by means of the fasteners.

### CIRCULAR BENDING OF STRIPS AND SHEETS

Preseamed sheets and strips can be made convex or concave by means of a circular bending machine. The minimum radius of curvature for concave sheets is 3 m. The equivalent minimum radius of curvature for convex sheets is 600 mm (with a maximum material thickness of 0.8 mm).

It is possible to work one side at a time, which makes it possible to bend helical sheets and strips.



The press braking machine makes the manufacture of complicated details easier.



Machine processing by computers.

## SEAM DRESSING

In the case of roof covering, the longitudinal standing seam in the metal strip is dressed in a seam dressing machine (preseaming machine). In this way, the standing seam can be dressed quickly and evenly, even when the metal strips are long.

The strips is fed directly from the roll to the machine. The seam dressing machine is programmed with data on the length and the number of metal strips, and can be adjusted to accommodate strip widths of between 300 mm and 800 mm. It can be run one side at a time, and can dress non-parallel seams on both sheets and strips. These strips can be seamed to give either two low or two high seams.

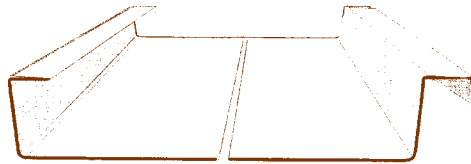

Seam sealing equipment for both double standing seams and vertical angle seams.

## SEAM SEALING EQUIPMENT

Seam sealing equipment is used on building sites to complete the seaming of the presealed strips.

Seam sealing equipment with adjustable pulleys is available for convex roof surfaces. This equipment makes it possible to seal standing seams for curved strips and sheets.

The seam sealing equipment can be adjusted so that it can also be used for sealing angle seams.

## FIBER LASERS FOR CUTTING COPPER AND COPPER ALLOYS

Fiber Laser cutting offers an advanced alternative to conventional cutting processes. Copper has rarely been cut by a laser by conventional laser technologies. This is due to copper being highly reflective to the wavelength of CO<sub>2</sub> lasers. Fiber lasers are ideal for highly reflective metals such as copper and brass. The most common fabrication methods are water jet cutting and stamping. Fiber lasers provide precision, accuracy and consistency, and are a direct replacement for these conventional technologies. Also the fiber laser based welding is possible to carry out with copper.

## MANUAL WORKING

The heavy machinery found in sheet-metal shops is also complemented by smaller items of machinery, both manual and electrical, which are used for manufacturing details in short runs.



## THE POSSIBILITIES OFFERED BY SHEET METAL

Sheet metal offers a wide range of possibilities when it comes to functional roof and facade coverings. Its compactibility often tempts architects and designers to want to shape it in a way which is not always possible using the equipment available at sheet-metal shops. And that is where the skill of the sheet-metal worker is very useful.

Sheet metal can be bent in only one direction at a time. In the case of surfaces of double curvature, the sheet has to be stretched and or upset, or else a number of sections have to be joined together.

Upsetting (shrinking) the upper flange and then stretching the lower flange to an equivalent extent to form a Z-shaped profile forces the profile to bend.

Upsetting and stretching can be carried out on flanges no more than 70 mm wide.

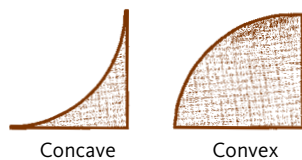

It is possible to bend preseamed sheeting into a convex or a concave shape using machinery.

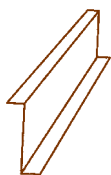

Z-shaped profile.

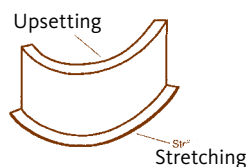

Bent Z-shaped profile



A Z-shaped profile which cannot be upset and stretched into the right shape.



It has to be manufactured in three sections which are then joined together by means of seaming, soldering or welding.

Development is one way of determining in advance how contours and shearing lines will look in a design.

After extension has been carried out, the sheet metal is bent or folded into the intended shape and then joined to other roofing sheets.

## DEVELOPMENT ROOF FLASHINGS

When sheet-metal workers create pipe flashings around circular vent pipes and blowpipes, they develop the pipe flashing first.

The pipe flashing is sheared, shaped and seamed before finally being attached to the pipe flashing plate.

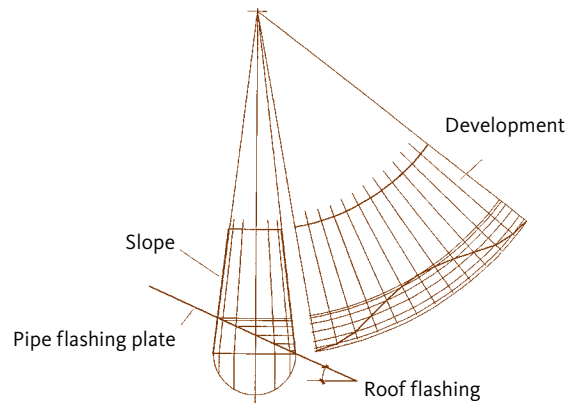

## DEVELOPING CORNER MOULDINGS

Corner mouldings can be moulded using templates so as to ensure that they fit well. It is also possible to extend the corner moulding carefully.

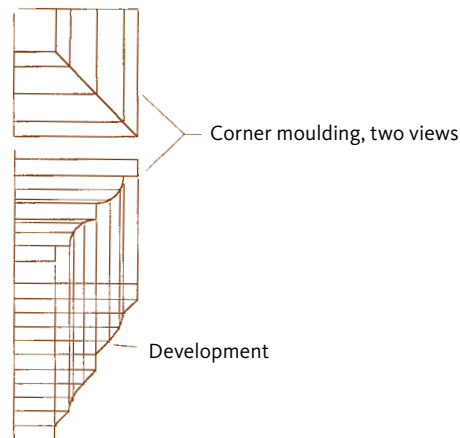



## HAND TOOLS FOR WORKING BUILDING PLATE

Folding tongs



Tinmen's tongs



Universal pliers



Roofing shears (pelican shears)



Tinsmith's hammer



Roofing tongs



Adjustable shears



Scaling iron



Hole cutter



Double folding tongs



Plastic mallet



Stone hammer





# Seaming, jointing

The most common seam dressing machines in use are designed for double seams as that this is generally the standard method used for seaming together panels and strips along their lengths.

One variant of the double standing seam is the angle seam, which is used in particular for seaming facade sheeting.



## BATTEN ROLLS / ROLL CAPS SYSTEMS

Using roll caps seams is a very old roof covering method, in fact one of the very oldest. Thus this is a well tried and tested method which has proven to work exceptionally well and give a very long service life.

It is now common to combine the capping seam method with other seaming methods such as standing seams.



Capping covering with horizontal moulding seam.



Capping covering with tilting moulding seam.  
Capping covering, two embodiments.

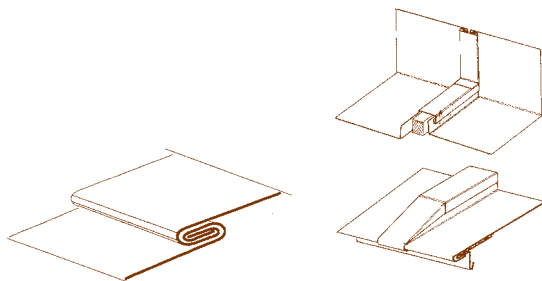

Horizontal double seam.

Example of seam termination at overhang and ridge at capping covering.

In the case of panel covering, the panels are seamed together using horizontal double seams to form longer units.

An enlarged single lock welt can be used as a movement joint on steeply sloping roofs.

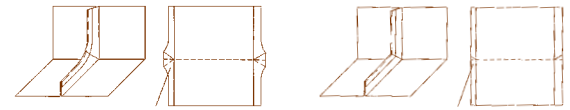

Filler metal  
Tapered seam. Always requires filler metal in the standing seam.

No filler metal  
Folds in standing seams require no filler metal.

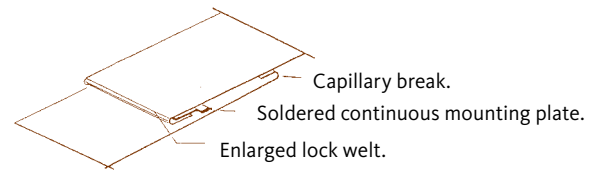

Example of soldered continuous mounting plate.

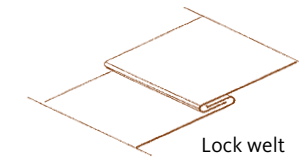

The phases of the manufacture of a connecting seam.

The use of the strip covering method, which is becoming more and more widespread, has also resulted in the development of seaming techniques. Nowadays, there are techniques which are better able to absorb material movements than the older methods of horizontal double seaming could have permitted.

All soldering in continuous mounting plates in movement joints or forming connecting seams to guttering, box gutters or valleys allows the thermal movements of the material.

Roof coverings and details such as gutters, cover flashings and encasements are connected on site and seamed manually.

## Joints

Lap joints in flat sheet metal can be applied in the case of narrow details and where there is no risk of the penetration of water. The free metal edge must be provided with a casing.

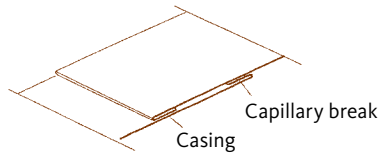

Lap joint with casing and capillary break.

Lock joints are used for mouldings and flashings where there is little risk of the penetration of water.

Lock joints permit concealed attachment of the sheet metal.

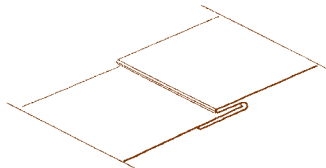

Lock joint

Profiled sheet is joined together by means of sidelaps and butt joints. The joints are attached by means of rivets or screws.

The sheeting is screwed onto the support.

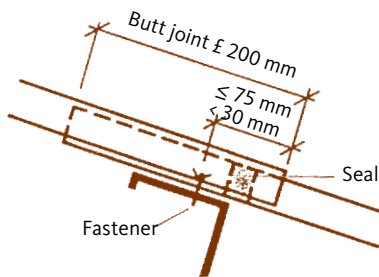

Butt joint

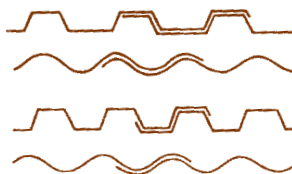

Sidelap

## WELDING, BRAZING, SOLDERING

Copper and most copper alloys can be welded and soldered by easily standard methods. The following pages show the foundations for welding, brazing (hard soldering) and soft soldering of ductile alloys. (Max temperature for soft soldering is 450 °C).

Weldability and solderability expressed as figures for copper sheeting (99.95 % Cu, Cu-DHP) and brass sheeting (65 % Cu + 35 % Zn, CuZn35).

The grading scale is as follows:

5 = very easy to carry out

4 = easy to carry out

3 = possible to carry out to an adequate extent

2 = difficult to carry out

1 = cannot be carried out with good results

METHOD		
<b>Fusion welding</b>		
Gas welding	4	4
Metal arc welding	2	2
Gas-shielded arc welding	5	3
<b>Pressure welding</b>		
Spot and seam welding	3	3
Butt welding	4	4
Flash welding	3	3
<b>Braze welding</b>		
Using brazing solder	5	1
<b>Brazing (hard soldering)</b>		
Using silver solder	5	5
Using silver phosphor copper solder	5	5
Using phosphor copper solder	5	2
Using brazing solder	4	1
<b>Soft soldering</b>		
	5	5

To be able to weld copper and copper alloys and produce good results, it is necessary to know a little about their properties.

### **Copper**

Above all, the following properties of the metal should be taken into account during welding:

- » it has high thermal conductivity
- » it has great potential for thermal expansion
- » it has a tendency to release gases when in a molten state. These gases are then given off when the metal solidifies and give rise to pores in the solidified metal
- » With hard temper copper it softens in the area known as the heat affected zone during welding

*The thermal conductivity* of copper at room temperature is approximately five times greater than that of steel, and at 1,000 °C it is approximately 15 times greater. This means that the heat is conducted away from the welding point much faster in copper than is the case for steel. Therefore, thick metals sometimes have to be preheated. During welding, it is important to ensure that there is a good supply of heat to the welding point, thus resulting in a sufficiently large molten pool.

*The thermal expansion* of copper and copper alloys during welding is approximately 100 % greater than what composite steel and in a solid state is approximately 50 % greater than in the case of composite steel.

*The tendency to absorb gases* applies above all to oxygen and hydrogen. Here, we differentiate between two different types of copper: oxygen bearing copper and deoxidised copper.

The latter is deoxidised using phosphorus, which means that it does not contain oxygen, but instead a small excess of phosphorus. The absence of oxygen promotes the welding process, and deoxidised copper is the type of copper most suitable for welding. Phosphorus in the copper also reduces its thermal conductivity, which is a positive aspect as regards welding.

Oxygen containing copper is very susceptible to hydrogen during welding. Hydrogen from the gas flame penetrates the metal, reacts with the oxygen and forms water vapour. This water vapour results in the formation of pores and fractures in the grain boundaries in the heated area surrounding the welded joint. Both of these effects impair the results. Therefore, oxygen bearing copper must never be welded or heated using a hydrogenous flame. (Bear in mind that an oxyacetylene flame contains hydrogen in the outer flame even when it is set to an oxygen deficiency.)

In unfortunate circumstances, the oxygen from the air or from the gas flame and moisture from the workpieces, may be absorbed into the weld and cause problems as described above. Therefore, it is necessary to work under conditions which ensure that the risk of the absorption of gases (oxygen, hydrogen) is eliminated, or at least is kept as low as possible.

*Hard temper copper* softens when heated. Therefore, welding a hard metal always means that a more or less wide area around the welding point softens and takes on properties which correspond to those of an annealed metal. The extent depends partly on the welding method used. During gas welding, this area is larger than is the case during gas-shielded arc welding.

### **Brass**

The thermal conductivity of brass is lower than that of copper. Therefore, less heat and preheating are required when welding brass.

Brass contains zinc, which has a low boiling point (907 °C). This means that welding results in vaporisation of the zinc, which can result in porosity in the weld. The greater the zinc content of the metal and the higher the welding temperature, the greater the vaporisation of the zinc. It is possible to reduce this vaporisation and the problems it causes by means of filler metals which result in a layer of oxide on the surface of the molten pool.

Many brasses contain lead. The risk of porosity and cracks occurring during welding means that it is preferable to use soldering when dealing with these alloys. Special brasses containing large quantities of aluminium demand the use of special techniques.

## FUSION WELDING

### Preparing joints, joint types

It is important to ensure that all joint surfaces are clean and free of grease, moisture and oxide. Joints should be prepared immediately prior to welding if possible.

Joints can be prepared by means of sawing, milling, planing, chiselling and grinding.

Above all, when it comes to gas welding large areas of copper, the thermal expansion properties of the metal mean that it is necessary to make the joint gap tapered in the manner shown below. The edges of the joint are held in position by means of clamps, which are removed as welding progresses. This is preferable to tack welding. Welding begins and is carried out in the order shown in the figure. 12–15 mm/m is an appropriate taper to use. It is also possible to use a fixing plate. It is possible to pass hot water through the jaws of the clamps in order to minimise the dissipation of heat.

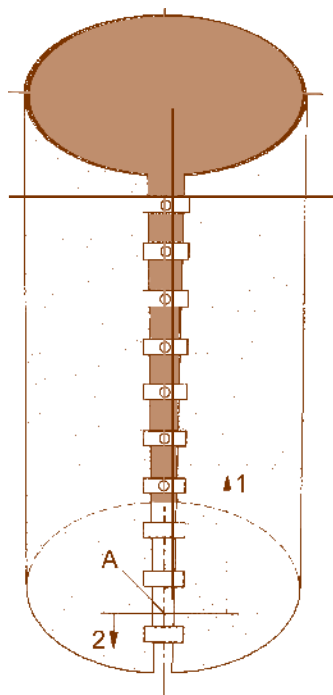

Shaping a welded joint when welding a cylindrical detail made of copper sheeting. Welding begins at point A and continues in direction 1. When this part has been welded, it is necessary to start again at point A, this time continuing in direction 2. (This principle also applies to the welding of flat sheet metal.)

The thermal conductivity of brass is lower than that of copper. This means that there is less thermal expansion in brass metals. In this case, the taper shaped design as shown in the figure is not required: instead, tack welding can be used.

### Filler metals

Filler metals in the form of straight rods are used for gas welding and manual TIG welding. It is important to ensure that the surfaces of these rods are clean and dry so as to ensure a high-quality welded joint.

Filler metals in the form of wire wound onto a spool are used for automated TIG welding and MIG welding. This wire has to be packed in such a manner as to ensure that it is not damaged and does not get damp or dirty during transportation and storage.

The filler metals used vary depending on the alloy being welded, and they can also vary depending on the welding method used. Sometimes a filler metal is used which is of a different composition to the metal to be welded. The welded joint can then take on properties different to those of the parent metal. In every case of this kind, it is necessary to be able to assess the consequences of this, such as colour differences, physical differences or the risk of galvanic corrosion.

### Flux

Flux is used primarily in the case of gas welding, but it is sometimes also used with other welding methods. Flux consists of boron compounds with the addition of oxide-dissolving metallic salts. When welding alloys containing aluminium, it is necessary to use a flux which contains fluorides. These dissolve the aluminium oxide which readily forms and which melts only at temperatures as high as approximately 2.000 °C. Fluxes are available as both powders and pastes.

When using fluxes which contain fluorine, it is necessary to ensure that there is a good extraction system in operation for removing the gases given off during welding. Once welding is complete, any deposits from the flux should also be removed as these may lead to corrosion.

### **Copper – gas welding**

An oxyacetylene flame is used as the source of heat. In the case of metals more than 2 mm thick, the metal should be preheated to a temperature of 300–700 °C. Larger welding nozzles are required than for welding steel: as a rule of thumb, nozzles one number larger should be used for metal thicknesses of less than 5 mm, and nozzles two numbers larger should be used for thicknesses in excess of 5 mm.

The welding flame should be set to normal or only slightly oxidising. Excess oxygen in the flame can cause oxide inclusions in the welded joint. Welds are often made upwards by vertical position welding. In the case of thicker metals, it is expedient to use two flames, one on either side. If possible, only one bead should be welded on each side in order to avoid thermal stresses which are too great and risk cracks forming.

The welded joint can be beaten after welding. It is best to weld in lengths of 150–200 mm, which should immediately be beaten while the metal is still red hot. Beating gives the welded joint a tighter structure, thus resulting in better strength and ductility than when it is not beaten.

Oxygen bearing copper should not be gas welded. If this is unavoidable, a reducing flame must not be used.

### **Copper – TIG welding**

Direct current arc is generated between the workpieces and an electrode connected to the negative pole of the direct current source. This electrode is made of tungsten, with an additional of thorium oxide.

During welding, the molten metal and electrode are surrounded by a protective gas: argon, helium or a mixture of these. It is sometimes necessary to protect the underside of the welded joint with gas in order to obtain pore-free joints. The filler metal is inserted into the arc in the same way as in gas welding. Thin workpieces can be welded without the use of filler metal.

The TIG method is generally used when welding thin sheet metal. Single-sided welding is adequate in the case of metals up to 4–6 mm thick. It may be necessary to use two-sided welding in the case of thicker metals: this method can be used for welding metals up to 18 mm thick. Preheating is not necessary in the case of

metals up to 4 mm thick. Preheating to a temperature of 300–600 °C should take place for thicker metals. The current strength, wire diameter and gas flows are shown in the adjacent table.

The TIG method can be used for both semiautomatic and fully automatic welding. It is not necessary to beat the welded joint. The filler metal provides strength values which are slightly higher than those for soft annealed copper. This method results in a close solidification structure which helps to give the metal strength.

### **Copper – MIG welding**

Direct current arc is generated between the workpieces and a consumable electrode. The electrode is the positive pole. Argon is normally used as a protective gas, but mixtures of argon and helium may also be used. The MIG method is used for metals more than 6 mm thick and facilitates the rapid buildup of welded joints. The MIG method is sometimes also used for metals thinner than those indicated here. In such cases, equipment which works with thinner wires is also used.

In the case of metals more than 12 mm thick, it is common to use a combination of TIG and MIG welding. The first bead is welded using the TIG method, and subsequent beads are MIG welded.

Preheating to a temperature of 300–600 °C is common in the case of metals more than 8 mm thick. If preheating is carried out, it is possible to maintain a lower electrode temperature, which reduces the vaporisation of the metal.

It is not necessary to beat the welded joint, although sometimes this is done.

The current strength, wire diameter and gas flows are shown in the following table.

DATA FOR TIG WELDING OF COPPER (99,95 % Cu, Cu-DHP). PROTECTIVE GAS: ARGON							
Type	Sheet thickness mm	Joint type	Current strength A	Wire diameter mm Electrode	Filler	Gas flow l/min	Weld rate mm/min
Manual	1.5	1 <sup>1)</sup>	50 – 175	1.2 – 2	1.5 – 2	7	–
	3	V	150 – 200	3.2	3	7	–
	6	X <sup>2)</sup>	2 x 180	4.8	4	2 x 7	–
	10	X <sup>2)</sup>	2 x 260	4	5	2 x 8	–
Automatic	1	1 <sup>1)</sup>	160	3.2	1.2	8	1,200 <sup>3)</sup>
	1.5	1 <sup>1)</sup>	240	4	1.2	8	800
	3	1	330	4	1.2	8	200

1) Also double flanged butt joint without filler metal.

2) Two-sided welding.

3) Considerably higher rates can be used for thinner metals.

DATA FOR MIG WELDING OF COPPER (99,95 % Cu, Cu-DHP). PROTECTIVE GAS: ARGON					
Type	Sheet thickness, mm	Joint type	Current strength, A	Electrode diameter, mm	Gas flow, l/min
Manual	6	1	250 – 320	1.6 <sup>1)</sup>	20
	13	V	330 – 380	1.6 <sup>1)</sup>	20
	25	V, U	330 – 380	2.4	20

1) 2.4 mm can also be used.

### Brass – gas welding

When gas welding brass, it is possible to use welding nozzles of the same size as those used when welding steel. Excess oxygen (30–50 %) in the flame is recommended so as to avoid too great a vaporisation of the zinc. The filler metal should contain silicon: this reduces the vaporisation of the zinc and permits the welder to use slightly less excess oxygen than would otherwise be the case. Preheating the joint helps to form a close welded joint. Vee joints are preferable.

When welding nickel brass, slightly less excess oxygen should be used than is the case when welding other kinds of brass. This is due to the risk of nickel oxide. These alloys are susceptible to overheating and so rightward welding should be used.

### Brass – TIG welding

TIG welding is to be recommended for thin metals. This method results in fewer pores being formed than is the case with gas welding. Alloys containing a high percentage of zinc can be difficult to make tight. In some cases, it may be better to use an alternating current arc: this maintains lower temperatures and results in less porosity and vaporisation of the zinc than the direct current arc. The arc should be aimed at the molten pool and welding carried out as quickly as possible in order to keep the temperature as low as possible.

In the case of thicker metals, preheating to a temperature of 200–400 °C is recommended. This permits a lower arc temperature to be used, thereby resulting in less vaporisation of the zinc. As a rule, beating is not necessary.

Brass containing aluminium is welded using a high-frequency superimposed alternating current. Preheating to a temperature of 200–300 °C is recommended

for thicker metals, and two-sided welding should be carried out in this case. After welding, the metal should be heat treated at a temperature of 500–550°C for approximately five minutes in order to remove any welding stresses.

The current strength, wire diameter and gas flows are shown in the adjacent table.

### Brass – MIG welding

This method is not particularly common on account of the high arc temperature which is required. This method results in great vaporisation of the zinc unless a very specific welding technique is used. Thick metals should be preheated to a temperature of 200–400°C. Combinations of TIG welding and MIG welding are used, especially when welding thicker metals.

### Special welding methods

In many instances, further development of the basic methods and specific welding methods, such as pulsating arc welding, give benefits as well as good results when working with copper metals.

### Plasma welding

This method can be used on copper and copper alloys, including material thicknesses down to about a hundredth of a millimetre.

### Electron beam welding

This is a method which has proven to give good results when used on deoxidised copper and zinc-free alloys. Welding takes place in a vacuum with no filler metal and results in an extremely thin welded joint. This method can also be used to attach other metals to copper.

**DATA FOR TIG WELDING OF BRASS (65% Cu + 35 % Zn, CuZn35). PROTECTIVE GAS: ARGO**

Type	Sheet thickness mm	Joint type	Current strength A	Wire diameter mm		Gas flow l/min	Weld rate mm/min
				Electrode	Filler		
Manual	2.5	1	120	2.4	1.5 – 2	10	–
Automatic	2.5	1	200	2.4	2.4	8	500

### **Joining together different metals**

Copper and copper alloys are sometimes joined together with other metals such as steel. In such cases, it is necessary to take into consideration the differences between the metals – the strength at high temperatures, thermal conductivity, thermal expansion, fusion heat and melting temperature, etc. – and how these will affect the weld. When joining copper to steel, in particular, the risks of the brittleness of the solder in the steel should be taken into account. Fillers have to be selected with both metals in mind. Attempts should always be made to melt down as small a portion of the parent metal as possible.

### **Checking and inspection**

The following are good ways of checking the quality of a welded joint: visual inspection, radiographic inspection, inductive testing, crack indication using a penetrant fluid, and test loading.

### **Joint properties**

As a rule, TIG welded or MIG welded joints have strength properties the same, or even slightly better than, the parent metal after it has been soft annealed. Gas welded joints may have a slightly lower tensile strength and elongation than the parent metal, but often in this case the metal is beaten in order to increase its strength. It should be borne in mind that welding can, in the case of brass, result in stresses which can lead to stress corrosion. Stress relief annealing eliminates the risk of this.

## **BRAZING (HARD SOLDERING) AND BRAZE WELDING**

### **General**

Both brazing and braze welding are joining methods which use filler metals with working temperatures in excess of 450°C. In the case of brazing, the joint is formed by allowing the filler metal to penetrate between the surfaces of the joint in a capillary gap. In the case of braze welding, a butt joint or fillet joint is used. This joint is filled in more or less the same way as in fusion welding. In both cases, welding temperatures below the melting temperatures of the workpieces are used.

Details made of copper sheeting which are difficult to seam can be hard soldered using silver phosphor copper solder. This results in a ductile, strong and water-tight connection between the sheets.

### **Alloys**

The working temperatures are so high that as a rule, hard metals soften during the soldering operation.

### **Copper**

When brazing oxygen bearing copper you must not use reducing (hydrogen containing) atmosphere or heat source. Oxygen bearing copper can easily be brittle by hydrogen diffusion into the metal. (See page 140.)

All coppers, with the exception of oxygen bearing copper, can be both brazed and braze welded.

### **Brass**

Plain brass can be brazed. If it contains a high proportion of copper, it can also be braze welded. It is difficult to braze weld alloys containing low proportions of copper because the melting temperatures of the parent metal and the solder (which is normally of brass type) are almost identical. Brass which contains lead may be susceptible to hot cracking. These metals should be allowed to cool slowly, and workpieces must not be water cooled after soldering.



## **Solders**

Brazing solder has high working temperatures and can therefore be used only for metals with correspondingly high melting temperatures: copper, brass containing a high proportion of copper, and steel. It is necessary to work with an oxidising atmosphere or flame in order to minimise the vaporisation of zinc from the solder.

Phosphor copper solder and special silver phosphor copper solder are very thin fluids. These can be used without flux when hard soldering copper. When soldering alpha-beta brass, the solder may have a tendency to penetrate into the grain boundaries of the parent metal and thus result in impaired strength.

Among the silver solders, the solders containing cadmium are the most common on account of the fact that they are thin fluids, have low working temperatures and allow short soldering times. Recommendations exist for health reasons which are important to take into account when using solders containing cadmium. For example, these solders must not be used in water supply pipes. It is important to ensure that there is a satisfactory extraction system in place to extract the poisonous fumes which are given off when soldering using any solder containing cadmium.

The health risks associated with solders containing cadmium have led to cadmium-free solders becoming more and more common, it is obviously to use these.

## **Fluxes**

Fluxes are used during hard soldering, with one or two exceptions. Only the soldering of copper using solders containing phosphorus, furnace brazing in a protective gas using a parent metal and using solders containing no zinc or cadmium, can be carried out without the use of flux. Different types of flux are used depending on the working temperature of the solder and what metal is being soldered. Boron compounds of various types are the main component of flux.

As a rule, fluxes are corrosive, and therefore any deposits from the flux must be removed after soldering. Fluxes are listed in accordance with standard DIN EN 29454-1.

## **Pretreatment**

Surfaces to be joined together must be clean. Oxide, dirt, grease, etc. must be removed by means of mechanical or chemical treatment: cleaning, brushing, degreasing or pickling.

## **Joint structure**

Joints are shaped as fillet joints, vee joints or double vee joints during brazing.

During hard soldering, joints are shaped with a gap for the solder to penetrate through by means of capillary action. In the case of most solders, 0.05–0.2 mm is an appropriate gap width. It is important to ensure that the gap is no wider, as the wider the gap, the less ability of the solder has to penetrate into the gap and the weaker the joint. Gaps should ideally be in the order of 0.1 mm. The same is true of gap widths at soldering temperatures, thus that it is necessary to take into account the different properties of metals under thermal expansion which may affect the width of the gap when the metal is heated.

## **Flame brazing**

An oxyacetylene flame is normally used. The workpieces are heated to working temperature using the flame and the solder is then applied without melting it down in the flame.

Avoid flame brazing oxygen bearing copper as there is a risk of hydrogen embrittlement. If it is necessary to flame braze oxygen bearing copper, it is necessary to be extremely observant to ensure that the flame is set to normal or only slightly oxidising.

When brazing brass using a brazing solder, as low a temperature as possible should be used so as to reduce the amount of vaporisation of the zinc. For the same reason, the workpiece should be heated quickly using an oxidising flame.

## **Furnace brazing**

This method is used for hard soldering. Solder and flux (where appropriate) are applied before the metal is placed in the furnace. Furnace brazing is particularly

suitable for mass production as it permits a large number of details to be soldered at the same time.

Flux used in combination with furnace brazing can easily result in corrosion and deposits in the furnace, so a reducing protective gas is often used instead of a flux.

One prerequisite which applies if this is to work is that the metal must not be oxidised: oxygen bearing copper must never be furnace brazed in a reducing (i.e. hydrogenous) atmosphere.

During soldering in a protective gas using a solder containing zinc or cadmium, it is necessary to watch out for vaporisation as this poses a risk to health.

### **Cooling after soldering**

Copper can be cooled rapidly after soldering. Other alloys, on the other hand, should be permitted to air cool so that they are acclimatised slowly.

### **After-treatment**

Deposits from fluxes can be corrosive. Therefore, it is necessary to ensure meticulously that these have been removed from the metal.

### **Joint properties**

The strength of a soldered joint depends not only on the properties of the parent metal, but also on the structure of the joint and the soldering technique used. The seam of a soldered joint always contains a material which differs from the rest of the joint to some extent. It is important to understand the effect of this correctly. If this is not taken into account, the zinc may be stripped from a brass joint in a copper detail when the joint is exposed to water, for example, while the rest of the material remains intact. Joints can also cause galvanic corrosion or themselves become corroded due to their composition, should this differ from that of the parent metal.

## **SOFT SOLDERING**

### **General**

Copper and copper alloys are very easy to soft solder, with a few isolated exceptions. Soft soldering can be used to reinforce and seal seams, e.t.c.

### **Copper**

Soldering copper poses no difficulties.

### **Brass**

Soldering brass normally poses no difficulties. In adverse cases, details with high internal stresses which have been cold worked vigorously can exhibit brittleness of the solder due to the solder penetrating into the grain boundaries of the material. If the solder method is adjusted so that the joint is heated to a temperature of approximately 300 °C before application of the solder, such effects are eliminated.

Brass which contains aluminium is difficult to soft solder using the standard flux compositions which are generally used if the aluminium content exceeds 1–1.5 %. Brasses containing aluminium can be pickled in a 20–30 % sulphuric acid solution immediately prior to soldering.

### **Solders**

Tin lead solders were earlier commonly used as soft solders. Now lead free solders have been developed. They are based on tin with additions of copper (SnCu3) or silver (SnAg3). Besides these solders, which are considered to be the most common kinds, solders of very specific compositions which are designed for soft soldering are also used.

Solders with high melting temperatures are used for details which have to be able to operate at slightly raised temperatures and in which the strength of the common tin lead solders is insufficient. Solders with very low melting temperatures are used in structures containing details with a limited heat potential.

The shear strength of capillary soldered joints at room temperature is in the order of 20–40 N/mm<sup>2</sup>. This is time dependent, the greater the load time, the weaker the joint becomes.

## Fluxes

Fluxes are used for all soft soldering. These fluxes may be of various types depending on the conditions prevailing at the time of soldering.

Zinc chloride solutions with various additives are commonly used in cases where rapid, complete removal of the oxide on the workpieces or of the oxide which is formed when the workpieces are heated is required. Fluxes of this kind are aggressive, and it is necessary to meticulously remove deposits from these once soldering is complete.

Resins can be used when the use of aggressive fluxes is inappropriate. These are less effective, which means that the soldering rate is lower. Resins do not need to be removed after soldering as they have no aggressive action on the metal.

Metal chloride fluxes can be made less aggressive and resin fluxes more effective by means of additives. Compounds based on organic acids can also be used as fluxes.

Fluxes are available in the form of pastes and fluids. In some cases, they are added to the solders. It is common for ammonium chloride (sal ammoniac) to be added to zinc chloride solutions. Ammonium compounds can cause stress corrosion cracking in brass alloys subject to tensile stresses. Therefore, when soldering brass, it is always necessary to avoid using fluxes which contain ammonium chloride or any other ammonium compound.

Fluxes are listed in standard EN 29454-1.

## Joint structure

Capillary joints are the most common. The strength of the joint is dependent on the gap width. Between 0.05 and 0.2 mm is an appropriate gap width. However, it should be no wider than 0.1 mm so as to make the joint as strong as possible. The gap must have parallel sides or be slightly taper shaped so that the gap opening where the solder is applied has the greatest gap width.

## Pretreatment

The surfaces to be soldered together must be clean and free of grease and oxide.

## Soldering methods

Any of the following methods can be used for heating:

- » Soldering iron  
(cannot be used if the joint overlap is large)
- » Gas burner or blowlamp. LPG, town gas or acetylene may be used as the fuel gas
- » Dip soldering. This method is common for series or mass production
- » Furnace soldering
- » Resistance soldering
- » Induction soldering

## After-treatment

As mentioned above, it is important to remove aggressive flux deposits. This can be done by rinsing the metal in hot water.

## **RIVETED JOINTS**

The fixing method using what are known as blind rivets was invented in the early 20<sup>th</sup> Century. It was initially used in the aircraft industry. Blind rivets can be found in many materials and designs. Blind riveting is a well tried and tested principle for joining together thin sheets of metal.

### **Standard blind rivets**

The rivets are supplied with a cup or countersunk head. Riveted joints in copper are made using rivets made of copper or stainless steel, and the splints are made of stainless steel or bronze.

### **Pressureproof blind rivets**

Pressureproof rivets have a sealed body with a fully encapsulated cotter head. This, together with great radial expansion, ensures a complete seal when these rivets are used. Their encapsulated cotter heads permit these rivets to withstand greater shearing forces and vibration stresses than standard rivets.

### **Fitting tools**

A large number of different types of tool – everything from simple hand tools to pneumatic or battery operated tools – are available for fitting blind rivets.

### **Flawless joints**

The following are required in order to ensure that joints are flawless, sealed and have full strength:

- » The correct hole diameter
- » The correct clamp length
- » Correct fitting of the head
- » The correct distance between sheets

# Surface treatment

## MECHANICAL SURFACE TREATMENT

Copper and copper alloys have natural, attractive colours of their own. Moreover, they can be given a range of different tints and colours by means of surface treatment.

Shaped products are either annealed (soft) or cold worked (hard).

Annealed materials may be annealed in air and pickled, or bright annealed, often in a protective gas. As a rule, the surfaces are dry; there is no film of oil or the like on them. Pickled surfaces are normally matt, while bright annealed surfaces are, as their name implies, bright. Sometimes the pickled sheet metal undergoes a brushing process which gives it a specific pattern depending on which type of brush is used.

Cold worked materials are either rolled or drawn. Rolled materials are rolled either dry or using rollers coated with oil or an emulsion.

Cold rolled or drawn products have, as a rule, a thin film of oil on the surface when they are delivered. This layer is generally so thin that it is difficult to detect it, but it is of significance when it comes to surface treatment. It contains oxides, as well as chloride compounds and sulphur compounds.

If any kind of surface treatment is to be carried out, oil and oxides have to be removed, as well as surface contaminants from transportation and storage, the surface then has to be prepared before the surface treatment is applied. The nature of the coating influences the choice of pretreatment, cleaning method and polishing.

### Grinding

Grinding using abrasive belts or discs with combined abrasives is often carried out prior to polishing and metallising.

In the case of shaped products, grain sizes in the order of 180–220  $\mu\text{m}$  are as a rule sufficiently coarse to begin with, while grain sizes in the order of 80–100  $\mu\text{m}$  are sufficient for forged details. Surface speeds are typically 20–25 m/s.

Products with surfaces that are just ground also exist. The surfaces of such products are ground to various patterns – from coarse linear patterns to fine satin ones – using specific grinding techniques, metal brushes or fibre brushes, or by sand or grit blasting. Surfaces treated must be protected against discoloration by means of wax or clear lacquer as quickly as possible once they have been treated.

### Polishing

Sisal, cloth or felt discs are used with an uncombined polishing material such as pumice, tripoli, iron oxide or Vienna lime. The medium is supplied in liquid or solid form. Polishes should be easy to remove prior to surface treatment.

The peripheral speed of the disc is 20–45 m/s. Higher speeds result in a deeper polish.

Polishes are commercially available in liquid or solid form or as polishing pads for cleaning moderately discoloured objects. These are based on a combination of mechanical polishing and chemical dissolving. It is necessary to bear in mind that some substances contain ammonia, and, given the risk of stress corrosion, it is necessary to be extremely careful when removing the residues of these substances from brass objects after each treatment.

It is possible to eliminate slight discoloration by washing these objects in a 3–5 % solution of a weak organic acid such as oxalic acid or tartaric acid, or by adding finely powdered pumice.

It is an advantage if the polish or solution contains a corrosion inhibitor – which will impede and delay further discoloration.

## CHEMICAL SURFACE TREATMENT

### Degreasing

Degreasing may be carried out using the conventional agents available from specialists: organic and inorganic agents and alkaline aqueous solutions. Degreasing using trichloroethylene should be carried out in three stages (hot tri, cold tri, vapour) on highly contaminated objects. The use of vapour is sufficient in simpler cases.

In the case of the alkaline degreasing of brass, strong alkaline baths must not be used as these can discolour and corrode the surfaces ( $\text{pH} \geq 10$  for polished surfaces). The recommendations of the manufacturer should be followed regarding the procedure to be used.

In some cases, the use of ultrasound as an effect-enhancing agent in tri baths and alkaline baths may be justified if a high level of cleanness is required or if details with deep, narrow slots are to be cleaned.

### Pickling

In the case of pickling, chemicals are used to remove oxide layers, verdigris and other coatings from the surface of the metal. Sometimes, pickling can be restricted to just loosening the coating, which is then removed mechanically. In some cases, it is necessary to remove lubricant residue from the processing or working of the material carried out immediately prior to pickling.

It is necessary to differentiate between non-oxidising pickling and oxidising pickling. Only the oxide layer is affected during non-oxidising pickling, while the surface layer of the underlying metal is also affected during oxidising pickling.

### Non-oxidising pickling

The most common non-oxidising pickling bath which is used for copper and copper alloys is made up of an aqueous solution consisting of approximately 10 % sulphuric acid by volume. This pickling bath dissolves some of the oxides on the surface of the metal. However, cupric (I) oxide ( $\text{Cu}_2\text{O}$ ) reacts in such a manner that only some of its copper content remains in solution, while the rest precipitates. In the case of metallic copper, it precipitates in the form of a powder which

can be brushed off. In the case of brass, it precipitates in the form of a rather sticky copper buildup. Sulphuric acid baths result in a metallically clean surface only in cases when the surface was moderately discoloured to start with.

Copper is normally pickled at a raised temperature (40–60 °C). A better result is achieved at raised pickling temperatures in the case of other copper alloys, with the exception of brass.

Brass is ideally pickled at room temperature so as not to risk it being coloured red by the precipitation of copper. Even when pickling brass at the correct temperature, it can be difficult to avoid red coloration completely in non-oxidising baths and if the copper content of the brass is in excess of 75 %. When the copper content is in excess of 75 %, the oxide contains large quantities of cupric oxide, which can easily lead to the precipitation of copper. When the copper content is less than 75 %, the oxide is principally zinc oxide and so red coloration is unusual, as long as pickling is carried out at room temperature and the copper content of the bath is not too high. The pickling time in non-oxidising baths is approximately five to twenty minutes. Blowing air through the bath or keeping the material moving is recommended.

### Oxidising pickling

When the oxide layer is thick or sparingly soluble, or if a very clean metal surface is required, oxidising pickling is used. The bath is prepared by adding oxidising agents – primarily hydrogen peroxide, nitric acid or sodium bichromate – to the sulphuric acid bath. Nitric acid and sodium bichromate can be hazardous to the environment, and if possible their use should be avoided.

Hydrogen peroxide is available in stabilised form and with a long shelf life. It is appropriate to add 2–4 % hydrogen peroxide by volume to the ordinary sulphuric acid bath. Pickling should take place at no more than 40 °C. Where the oxide layer is thick, it is possible to economise with the hydrogen peroxide bath by preparing the metal in an ordinary sulphuric acid bath.

Sometimes bichromate needs to be added, in spite of its environmentally hazardous properties. Bichromate is more effective than hydrogen peroxide in that it removes carbonised lubricant residue and practically never colours brass red. It also provides a certain degree of passivation of the surface of the material which makes it less susceptible to discoloration in the long term. The composition of the bath can be 5–10 % sulphuric acid by volume, plus 30–70 g of sodium bichromate per litre of bath.

The pickling baths described above result in a certain amount of what is known as pickling bath fume over the surface of the bath. This can be counteracted by adding hydrogen (0.05–0.1 g/l) which provides a covering of foam over the surface of the bath.

Oxide layers containing nickel – on nickel brass, for example – can be difficult to remove by pickling in the baths described above on because that nickel oxide is extremely sparingly soluble. If stronger pickling agents are not desirable, it is possible to use heat treatment in a protective gas. The thin oxide layers which are difficult to avoid in this atmosphere are easy to remove by pickling by means of the methods mentioned above.

If the material is coated with sparingly soluble oxides, or if a high degree of metallic surface cleanness is required, bright dipping is particularly effective. This is commonly made up as follows: 500 ml of concentrated sulphuric acid +500 ml of concentrated nitric acid +10 ml of concentrated hydrochloric acid per litre of bath.

A more dilute and specifically bright dip mixture is as follows: 430 ml of concentrated sulphuric acid +70 ml of concentrated nitric acid +2 ml of concentrated hydrochloric acid +500 ml of water.

If the oxide layer is extremely thick and hardly soluble, it is possible to carry out first pickling in a bath containing concentrated nitric acid to which approximately 10ml of concentrated hydrochloric acid has been added per litre of water. After bright dipping, hot forged brass details may sometimes display varying tints. Subsequent pickling in a bichromate bath will even out these variations.

Baths containing nitric acid attack the metal quickly and intensively, which is why the pickling time is very

short. The metal is dipped briefly (for a few seconds) a number of times, followed by flushing with water.

During pickling, the bath gives off nitrous gases which are hazardous to health and can cause lung damage if inhaled. Therefore, it is necessary to ensure that the workplace is extremely well ventilated.

As the pickling bath is used, the acid content gradually falls but the metal content rises. Therefore, the levels should be checked continuously and adjusted or added to as required. Ordinary sulphuric acid baths should be refreshed when the copper sulphate content exceeds 120 g/l of pickling bath. Sulphuric acid baths, including those containing hydrogen peroxide, are suitable for electrolytic regeneration (the copper is plated onto cathodes). However, hydrogen peroxide is lost during this process. There are currently no practicable regeneration methods for chromate or nitric acid baths.

After pickling, it is necessary to thoroughly remove all residues from the metal. This is done by rinsing or flushing it in various kinds of water, finishing off with hot rinsing water so that the details dry off quickly. It is possible to add a corrosion inhibitor such as benzotriazole to the rinsing water to protect the metal from becoming discoloured again.

During the first rinse, it may be practical to include mechanical brushing in order to remove any oxide residues, copper powder, etc. still remaining and to further improve the result.

### **Polishing**

As mentioned above, special “bright dips” can be used which give an extra brilliant shine. There are many such alternatives available for chemical and electrolytic polishing, and these are primarily based on phosphoric acid.

The following is a mixture for chemical polishing which is used for the preparation of metallographic samples: 400 ml of concentrated orthophosphoric acid +400 ml of glacial acetic acid +200 ml of concentrated nitric acid +0.1 ml of concentrated hydrochloric acid. Polishing takes a minute or so at room temperature. Phosphoric acid (50 % by volume) goes to make up one example of a bath for electrolytic polishing. Polishing takes place over a minute or so at room temperature at a current density of 13–15 A/dm<sup>2</sup>.

Both of these methods give the best results on materials which do not contain lead.

## COLOURING

It is possible to produce a number of colours and tints on copper and copper alloys using wet chemical methods. Here, we will take a look at a number of common methods used to produce dark colours and a green patina. The metal must be pretreated thoroughly by means of degreasing and pickling for these methods to give satisfactory results.

### Dark colouring

*The cupric nitrate method:* The oxidation of the copper in the material takes place in heat, and cupric nitrate decays, with the formation of oxygen and nitric oxides.

The colouring bath is made up of 2kg of cupric nitrate to each litre of water. This liquid has a very long shelf life and can be stored in containers made of plastic, ceramic or acidproof steel. The process begins with the object being preheated to approximately 100 °C. The colour solution is then applied to the hot surface using a brush or by dripping it on to form a thin, even layer. The object is then heated to 200–250 °C in a furnace or using a gas burner until the object has become evenly dark across its surface. This takes place within 15 minutes or so. Soft soldered objects must be heated at a lower temperature and for a longer time so that the joint does not melt. Once the object has cooled, loose cupric oxide powder is brushed off. The procedure may need to be repeated in order to give the object an even, fine tint. Copper and brass take on a brown to black patina, while tin bronze turns brown. Nickel brass and aluminium bronze are difficult to colour.

When the metal treated with cupric nitrate is heated, nitrous gases which are hazardous to health are given off. Therefore, it is necessary to ensure that the workplace is ventilated effectively and extremely well. In addition, respiratory protective equipment should be worn when brushing cupric oxide powder off large surfaces.

*The chlorite method:* The oxidising agent in this case is sodium chlorite, which gives cupric oxide on the surface of the metal in an alkaline solution.

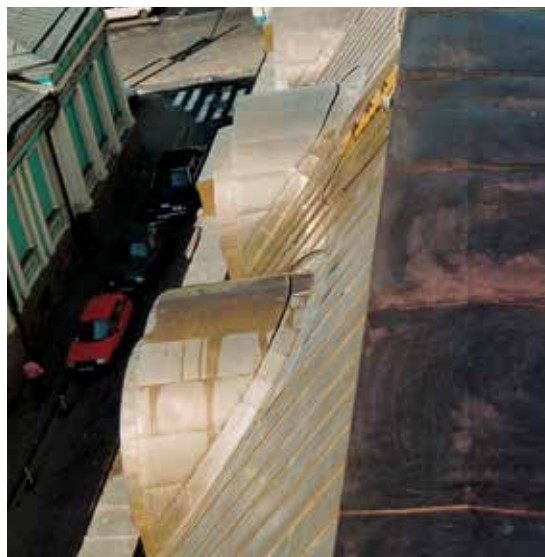

Dark oxidising on site using sodium chloride.

The colouring bath consists of 60 g of sodium chlorite and 120 g of sodium hydroxide per litre of water. As a rule, brass and bronze need to be precoloured in a bath containing a mixture of 100 g of sodium bromate or potassium bromate and 100 g of sodium hydroxide per litre of water. Both of these colouring baths have a fairly long shelf life. It is best to store and use these baths in containers made of acidproof steel. Ready-made commercial products are available for dark colouring metals in accordance with the chlorite method.

Chlorite baths are used for copper and alloys containing a high percentage of copper. The object is dipped in the bath, which is kept on a low boil. The dip time should be between three and 15 minutes. This is determined more precisely by the composition of the alloy, the dark tint required and the time for which the bath has been in use. Brass with a copper content of less than 90 % and bronze are normally precoloured in the bromate bath, which is kept on a low boil (3–15 minutes). After this, the object is rinsed in water and then attains the required dark colouring by being rinsed in a chlorite bath as described above.

To prevent the occurrence of blemishes, it is important to ensure that the object is rinsed clean after colouring and that the coloured surfaces are dried. Rinsing under running water and final rinsing in warm,



ideally deionised water and drying in hot air are recommended. This method gives the surface a brown to dark black patina with a velvety lustre.

Chlorites and bromates are very powerful oxidising agents. In solid form, they must not be subject to impacts or come into contact with inflammable substances as there may be a risk of fire or explosion. Chlorite attacks soft solder. It is possible to prevent attacks on solder joints by copper plating the object prior to colouring it.

In the case of copper, the chlorite method has been used for solar collector panels, inter alia. The coating must be thin: it is crucial to the result to ensure that the bath mixture, temperature and time are all co-ordinated so that the layer is not made too thick. The coating should be protected by treating it with an inhibitor or with a very thin coat of clear lacquer.

*The persulphate method:* Dark colouring takes place in an alkaline persulphate solution by means of the formation of cupric oxide on the surface of the metal. The colouring bath for copper contains 50 g of sodium hydroxide per litre of water, or for brass and bronze 100 g of sodium hydroxide per litre of water. In either case, 10 g of potassium persulphate (or sodium persulphate) is dissolved in the solution immediately prior to colouring.

The persulphate dilutes gradually, irrespective of whether the bath is used or not. Extra persulphate should be added every time an object is to be coloured. Containers made of acidproof steel are suitable for the storage of persulphate.

To colour an object, the bath is first heated and then placed on a low boil. The object is dipped in the bath, and 10 g of persulphate per litre of lye is carefully added. This treatment continues for five to ten minutes while the mixture is agitated. If oxygen ceases to be given off from the bath, the persulphate has been consumed. If a darker colour is required, the procedure is repeated using another 10 g of persulphate per litre of lye until the colour of the object is as intended. The object should be rinsed and dried well so as to prevent blemishes. This method results in a deep, dark patina but does not work on nickel brass.

Persulphates are powerful oxidising agents, and they should not come into contact with inflammable / combustible substances due to the risk of fire.

*The liver of sulphur method:* Potassium sulphide is the main component of liver of sulphur. This method results in a dark copper sulphide layer on the surface of the metal. In addition, small amounts of hydrosulphuric acid and sulphur are formed by secondary reactions.

Colouring takes place in a bath containing approximately 10 g of liver of sulphur per litre of water and which is made slightly alkaline using sodium hydroxide or soda. When colouring brass, an intermediate bath containing 50 g of copper sulphate and a couple of millilitres of concentrated sulphuric acid per litre of water is required. These solutions can be used in containers made of plastic or ceramic. The liver of sulphur bath has a limited shelf life, while the copper sulphate bath can be used for a very long time.

Copper and copper-rich alloys are coloured by agitating the metal in the liver of sulphur bath at a temperature of approximately 80°C for one to three minutes; or at room temperature, but for a longer time. It is also possible to apply the solution using a brush or brass brush.

Brass is coloured by dipping it in the liver of sulphur bath and then the copper sulphate bath in turn. The metal should be dipped for approximately thirty seconds or longer each time it is dipped, and it should be rinsed briefly in water before being dipped in the next bath. This procedure is repeated until the surface of the metal has attained the required tint. Both solutions can be applied using a brush or brass brush. The surfaces must be rinsed and dried thoroughly after colouring. The patina is brown to black in colour. Copper-rich alloys often take on reddish hues, while brass turns greenish or bluish.

A certain amount of hydrosulphuric acid is given off from the liver of sulphur bath and from used copper sulphate baths, this smells unpleasant and is hazardous to health. Therefore, it is necessary to ensure that the workplace is well ventilated.

*After-treatment:* Polishing of the coloured surface of the metal may be appropriate in order to remove loose oxide and sulphide powder and to produce an

even lustre. Polishing can be carried out using cotton waste, a soft cloth or a soft brush. The metal can also be polished using dampened powdered pumice or precipitated chalk if the surface is to be toned down.

### General

In the case of large surfaces which are to be dark-oxidised, we recommend the use of Nordic Brown, a factory-oxidised metal which has a dark brown oxide surface on both sides.

## ADDING A GREEN PATINA/

### Nordic Green PLUS

The reddish-brown surface of new copper changes to a dark brown colour after a prolonged exposure outdoors. Gradually, and depending on the climate and the atmospheric conditions, the copper begins to take on the characteristic green patina. Differing degrees of exposure to the wind and the weather result in varying shading which makes the surface of the copper sheeting vivid and exciting. For many architects and developers, the pale green patina is so attractive that they are keen to encourage its formation.

### Nordic Green PLUS

Immediately after application on Nordic Brown copper, the Nordic Green method results in a beautiful green patina with a colour and structure equivalent to those found in the patina which develops naturally. After application, the layer of patina is reinforced and transformed to the natural patina. After treatment with Nordic Green PLUS, the layer of patina matures in the usual way.

This method is ideal for use on all types of smaller production, but it also has clear benefits for repairs and supplementary work on surfaces where a patina has already formed.



Nordic Green.

The treatment with Nordic Green PLUS consists of three elements:

1. *Cleaning:* The surface to be treated with NG is first washed clean using an alkaline detergent (washing up liquid is usually fine). This is used to carefully remove grease and patches of oil. Rinse the metal and allow it to dry naturally.
2. *Dark Oxidation:* The Nordic Green PLUS patina can only be applied to a dark oxidised surface of the correct composition and structure. The oxidation can either be achieved naturally, chemically, or by using the factory oxidised product – Nordic Brown.

The Nordic Brown product has the specific composition and structure required to accept the Nordic Green PLUS patina. Should it be required to make a chemical oxidation, reoxidising over an area, which has been affected by structure required to accept the Nordic Green PLUS patina. Should it be required to make a chemical oxidation, reoxidising over an area, which has been affected by soldering flux for instance, this can be achieved by using a heated solution of sodium chloride (NG1). The heated solution should be applied to a clean copper surface and allowed to dry naturally, when the colour will change. The surface should then be rinsed, and any white deposit of salt removed. The process can be repeated if a deeper shade of brown is required.

3. *Patination*: A very thin layer of the patination agent is applied to the clean, dark oxidised surface using a brush or a spray. Finish off by rolling. The roller removes brush strokes and any uneven sections and also provides the opportunity to create a very specific surface structure. Select a roller which is appropriate to your requirements. Leave the patination layer to dry. The colour will become lighter as it dries.

Patination must not be done in direct sunshine on hot surface or when it rains. Protect the surface 1–3 days against rain. Usually one day protection is enough against moderate rain.

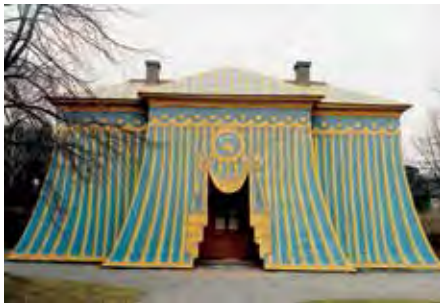

Paint on a copper facade in Sweden.



Facade, patinated with Nordic GreenPLUSLaajasalo, Finland.

As with a naturally formed patina, surfaces treated with Nordic Green PLUS take on the characteristic shading of copper. As patina develops unhindered by the Nordic Green treatment, surfaces will in the long term be transformed to natural patina.

Newly patinated metal may be delicate and should not be subject to rough handling. However, minor scratches sustained during the work are self-healing. In a short time, the Nordic GreenPLUS layer attains a durability comparable to that of a patina which has established itself naturally.

If possible, avoid working in temperatures of less than +10 °C or in direct sunlight. Surfaces to which the patina is not to be applied should be covered and protected against the patination agent. This is of particular importance as regards contact with as less noble metals, which can be affected by corrosion.

The patination agent NG2 can be stored at room temperature. Safety equipment such as lifelines, protective gloves, protective goggles and respiratory protective equipment should be used as required.

### Large patinated surface

In the case of large surfaces which are to be green patinated, we recommend the use of a factory-pre-patinated Nordic Green.

### Other colourings

It is possible to colour copper sheeting in colours other than those offered by the Nordic GreenPLUS method. For instance, it is possible to apply a red or a pale blue colour. In this case, the layer of colour has to be protected. For natural reasons, there is practically no interest in this kind of colouring as far as copper is concerned.

### Painting

If it is necessary to paint objects made of copper or a copper alloy, it is possible to use paints which are based on the binding agents referred to in the next section, “Surface protection”, in the paragraph dealing with clear lacquering. Otherwise, please refer to the instructions issued by the paint manufacturer.

## SURFACE PROTECTION

Copper and copper alloys are extremely corrosion resistant. However, the surface of these metals – either formed naturally or produced artificially – can be damaged if handled roughly or if it is left with no kind of care or attention. It is possible to delay or prevent changes or wear from occurring by applying various kinds of surface protection. Materials can also be ordered with plastic foils to protect the surface.

### Treatment with an inhibitor

In the case of copper alloys, it is possible to achieve temporary protection against discoloration by dipping the object in a hot solution containing 10 g of the corrosion inhibitor benzotriazole to each litre of water. In most cases, this treatment is carried out on sheets and strips prior to supply by the manufacturers of semifinished products. This inhibitor is also used to impregnate wrapping paper and interleaving paper. A film of oil will also provide temporary protection, either applied directly or picked up by rinsing the object in a thin oil emulsion which immediately dries.

### Clear lacquering

If a more permanent protection than that offered by treatment with an inhibitor is required, it is necessary to lacquer the object using a clear lacquer. The surfaces must be cleaned thoroughly, and the object must be lacquered immediately after the prior surface treatment. These lacquers dry at room temperature, but they can dry more quickly if the temperature is raised slightly. Too much heat must not be applied, however, as this may result in discoloration of the lacquered surface. Do not forget to follow the safety instructions issued by the manufacturer of the lacquer.

### Pyroxyline lacquer (known as zapon lacquer)

A cheap lacquer which was very commonly used in these circumstances in the past. This provides relatively good protection against discoloration on indoor materials. However, its protective effect is shortlived on materials exposed outdoors.



Clear lacquering on an entrance door

### Cellulose acetate butyrate lacquer, epoxy lacquer

Used mainly for indoor purposes. Epoxy lacquer is very resistant to chemicals, impact and abrasion. This is what is known as a two-component lacquer which requires heat treatment in order to harden. Both of these lacquers exhibit a tendency to darken indoors.

### Acrylic lacquer

This provides good protection against discoloration and is relatively resistant to chemicals, impact and abrasion. It can also be used outdoors, for instance for door and window sections, facade elements and decorative features.

INCRALAC is a special type of acrylic lacquer. It contains toluene as a solvent and benzotriazole as a corrosion inhibitor. INCRALAC provides protection against discoloration outdoors for at least five years. It can be applied by spraying, with a brush or by dipping the object in the lacquer. It has a very short drying time.

Test results measured for protective lacquers during long-term outdoor exposure have been achieved using a lacquer known as Stacryl 2. This has proven to have effective material protection properties which can last for up to seven years in a London atmosphere.

It is advisable to apply at least three coats of lacquer for use outdoors. One or two coats of lacquer is normally enough for indoor use. The optimum coat thickness is approximately 25  $\mu\text{m}$ .



Patination with Nordic Green PLUS Bier Tempel Bad Tölz, Germany.



### **Polyurethane lacquer**

If better abrasion resistance than that offered by acrylic lacquer is required, polyurethane lacquer can be used. This is available in variants which dry in the air at room temperature, but this takes place so slowly that an increased drying temperature is preferable. The optimum coat thickness is 5  $\mu\text{m}$ . Two coats are recommended. This lacquer is suitable for use on objects such as door fittings, handrails and banisters, kick plates and shop counters.

### **Silicone lacquer**

This provides the best protection for details designed for use at high temperatures and under relatively arduous conditions. This lacquer is not particularly resistant to abrasion, so there may be just cause to apply a coat of a more abrasion-resistant lacquer over the coat of silicone lacquer.

### **Relacquering**

It is possible to remove most air-drying lacquers using the type of solvent required for the specific type of lacquer. This should take place at as early a stage as possible (the discoloration stage) in order to ensure that the pretreatment prior to the relacquering does not become too complex.

### **Oiling and waxing**

Lacquering results in a robust surface which will remain maintenance-free for a long time. Oiling or waxing the copper materials regularly allows the lacquer to be maintained and a beautiful lustre to be refined. Oils commonly used for this purpose include liquid paraffin, linseed oil, castor oil and lemon oil. Waxes appropriate for use include mixtures of carnauba wax and turpentine or beeswax and turpentine. Hard waxes commercially available for use on car paintwork can also be used.

These oils or waxes are applied using a rag. It is possible to improve the protective effects of these substances by adding an inhibitor of triazole type, for example.



Nordic Green. Music Centre, Helsinki, Finland.

# Good house keeping

## MAINTENANCE OF ROOFS, FACADES, DETAILS

Maintenance, from both a technical and a financial point of view, is always a current topic for discussion. Over the last few years, many property owners have found how the cost of building maintenance has soared. Given this background, it may be very valuable to take a look at the factors which affect operations and maintenance all across the board as regards property management.

How long a service life do the various materials and functions in the building have? What level of quality should we opt for regarding building materials so as to ensure cost-effective management? How much should we add for routine maintenance?

It is a known fact that copper sheeting, in practically all forms has an almost unlimited service life on the condition that it is fitted correctly and is maintained to a reasonable extent. Checks and maintenance are elements which must not be viewed – the use of good materials notwithstanding – as a necessary evil. Quite the contrary: regular maintenance leads to control, as well as many financial benefits and privileges.

### Maintenance operations

There are three types of operation to be carried out when it comes to maintaining roofs.

- » Inspections, checks, cleaning
- » Maintenance in the form of repairs
- » Recovering and reconditioning

Any roof maintenance plan should contain the above three maintenance areas, and sufficient resources should be set aside in readiness for this.

The aim of regular maintenance is to ensure that the materials have the longest possible service life at as low a cost as possible.

### When should maintenance checks be carried out?

Maintenance inspections should be carried out once every two years or so, depending on the performance of the materials and the design of the building, its geographical location and climatic and atmospheric conditions. The condition of the roof is examined thoroughly and according to plan in the case of checks and inspections. Details must be checked and cleaned.

The aim of inspection is to detect at an early stage whether anything has sustained any damage or is under some mechanical threat.

### General information on damage to roofs

Essentially, the following are the main causes of damage to roofs:

- » Errors in design or planning
- » Poor workmanship, negligence
- » Damage or lack of maintenance
- » Inappropriate combinations of materials



Errors in design or planning. The icicles indicate that there is insufficient insulation and /or defective ventilation.

Leaks from roofs often provide the impetus for the commencement of work on the roof in the hope of being able to find the cause of the damage quickly and then being able to rectify it simply and easily. However, it may be difficult to determine the cause of damage in a short time, in spite of obvious resultant effects.

For instance, there may be many reasons as to why a drop of water exists: leakage through a hole, leakage at the point where a detail is fitted, leakage at openings, condensation, etc.

The point from which the water is dripping down may not be the precise location of the damage or the cause of the leak. The point at which the water is emerging may be a long way from the point at which the cause of the leak is located.

A perceptible sign of a leak in a roof does not necessarily mean that the cause of the leak is located in that very position. Roofs may easily spring a leak on account of diffusion or convection.

Establishing the cause of damage in a reliable manner which in the long run permits the real cause of the leak to be targeted and rectified may require thorough checking of the conditions as regards moisture and temperature and of the various operation states of the ventilation system. The causes of positive or negative pressure must be determined.

### **Cleaning gutters, inverts, outlets and gulleys**

Valleys are vulnerable sections of a roof. Water, snow and ice wear out the roofing materials. An incorrectly designed valley can burst if it ices up. Rubbish also gathers readily in channels and gulleys and can block the flow of water, resulting in standing water.

Standing water accelerates various degradation effects and also involves a risk of water pressure building up above seams and joints. This water pressure can lead to leakage in the long term. Valleys and gutters must be cleaned every year, and checked, perhaps many times a year in exposed areas.

When cleaning inverts and channels, these must be cleared of leaves, soil, loose objects etc. so that the waterbearing surface can be seen. Roof outlets and roof gulleys must be cleaned in a similar manner so as to prevent flooding.



A gutter in which rubbish, leaves, etc. have gathered by a gully.

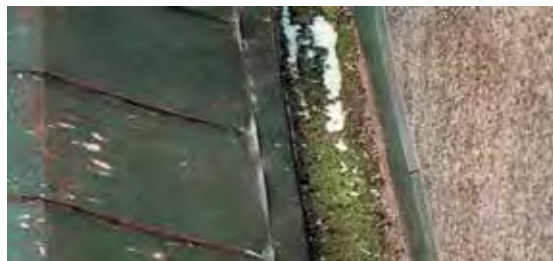

A valley which has not been cleared or cleaned for a long time. Moss and grass are growing in it.



Blocked gulleys can result in major stresses on the roofing materials.

Working on a roof always involves a risk of accidents due to something falling it. Access facilities and safety devices must be provided on the roof when work is to be carried out clearing snow, cleaning chimneys etc. Different requirements may apply for this depending on when the building was constructed, but in the case of older buildings what are known as retroactive demands may sometimes be placed on safety equipment. This means that it is necessary to supplement or replace defective roof safety devices within the scope of standard maintenance.





Checking the roof safety devices is a vital part of the maintenance inspection.



Roof safety device mountings in wooden bases must always be tightened. Lock joints, on the other hand, must not be tightened.

Mechanical damage may occur in the event of the careless clearing of snow, attachment of advertising signs, TV aerials, etc.

The mounting of the roof covering must also be checked. Points on the roof which are exposed to storms and winds can result in weakening of the mounting in the long term. Clips may for example be attached using only forged nails, particularly in the case of old roofs.

### Damage due to thermal movements

Over the last few years, the strip covering of roofs has become more widespread. These do not need to be checked during maintenance inspections, and maintenance of them is no different to panel covering. However, in the case of strip covering there is a risk

of damage occurring due to thermal movement. Damage may occur on account of expansion if details are designed incorrectly and the movement of the metal strips is impaired. Thermal movements can also cause damage to fasteners and sheeting if these are attached inappropriately or incorrectly.

Initially, the hole around the fastening becomes oval in shape, resulting in clearance around it. Long sheets move more, and therefore there is a risk of larger holes forming. Leaks can occur at the fastenings if the grommets are too small. If the recommendations of the manufacturer are followed as for, the positioning of movement joints, etc., there is little risk of damage.

Movements in the sheeting can also lead to fasteners (nails) being affected and creeping up out of the base (wood). In adverse cases, this can lead to shear failure in the fastener.



Even small surfaces such as dormers, have to be fastened carefully.

### Gutters

Gutters are used for roof drainage, together with either external or internal downpipes.

The following are examined in the event of maintenance inspections:

- » the slope of the gutter
- » the tightness of the seams and joints at gulleys
- » the fixings of pipe clips / framework
- » mechanical damage to the channel, for instance following the clearing of snow
- » corrosion damage, surface treatment
- » damage caused by expansion
- » connection between the gutter and the roof covering

In the case of slate roofs and tiled roofs, it is important to check the guttering and whether copious amount of water are dripping from the roof covering. There is a risk of fretting corrosion occurring in these details.

### Box gutters and valleys

Box gutters are usually used for roof drainage together with external downpipes. The following are examined during maintenance inspections:

- » the slope of the box gutter
- » the tightness of the seams and joints at gulleys
- » fixings
- » mechanical damage
- » damage caused by expansion
- » connection between the roof covering and the valley, such as edge sheets at felting
- » corrosion damage

If the box gutter is positioned such that any leaks may cause damage to the underlying wall, protective flashings must be fitted. Check that the protective flashings are fitted, and check their condition.

Valleys often have internal downpipes. There are three main types:

- » countersunk valleys
- » valleys with built-up slope
- » valleys without built-up slope

The following are examined in the event of maintenance inspections:

- » the slope of the valley
- » the tightness of the seams, joints and at gulleys
- » mechanical damage
- » damage caused by expansion
- » connection between the roof covering and the valley
- » corrosion damage
- » overflow functions



Always make sure that the gutter is kept clear of any rubbish.



Is the mounting fixed correctly?

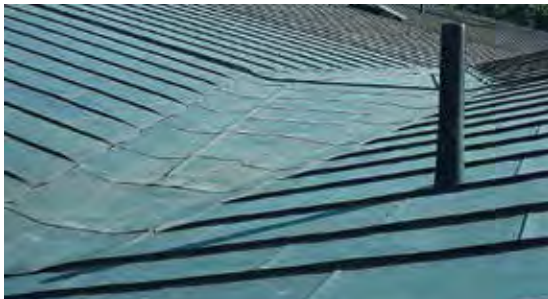

Is the valley tight? Are there any cracks in it, or any other damage?



Valleys – including gulleys – are some of the most important details of a roof and must be checked and maintained with precision. They should be cleared of snow in the winter, and this must be done carefully so as to avoid damaging the roof covering – use a wooden shovel.

### Valley gutters

Valley gutters are formed between two pitched roof areas or similar. Water runs down from these to some other drainage facility such as a box gutter, valley or gutter. The following are examined in the event of maintenance inspections:

- » the tightness of the seams
- » mechanical damage
- » damage caused by expansion
- » connection between the valley gutter and the roof covering
- » corrosion damage

### Gutters

Ice can form in gutters and downpipes and on the edges of roofs, even those expertly designed and fitted.

Powerful stresses and subsidence can lead to changes in the slope of the gutters. In worst-case scenarios, backfalls and standing water can occur. Where felt covering is fitted, the edge sheet may drag the felt apart. The following are examined in the event of maintenance inspections:

- » slope
- » the tightness of the seams
- » the edge sheet (corrosion), crack formation in the felt
- » fasteners (hooks)



Stresses caused by ice on the eaves, box gutter and downpipe.



When the facade is made of a material which absorbs water, the longitudinal joint must always face away from the facade in order to prevent damage to the plaster should ice cause a burst. The illustration shows a seam which has been burst by ice. This pipe section should be replaced.

### Downpipes

The formation of ice in downpipes can lead to the longitudinal pipe seam bursting. Poor joints can result in the pipes coming loose and sliding apart.

### Strainers, gulleys

The gulleys are the most vulnerable details in valleys. Water must not be permitted to penetrate, irrespective of which roofing material is used. The material used for the gulleys, including the strainer, is generally stainless steel or copper. The tightness of the gully connections must be checked carefully.

### Corrosive water

Sometimes holes may appear in the sheeting at the point where water meets the copper surface. The reason for this is almost always the fact that the water running down is acidic, in combination with intensive fretting which means that a protective oxide layer never has time to form at the point where the water meets the surface. If the running water contains sand from the felt or the tiled roof, this fretting becomes worse.



Is the downpipe union piece attached to the wall?



Rainwater should not be allowed to run onto any underlying roof without special drainage. Here, an open channel directs the water down to the gutter on the lower roof. The channel is attached to the nearest standing seams.

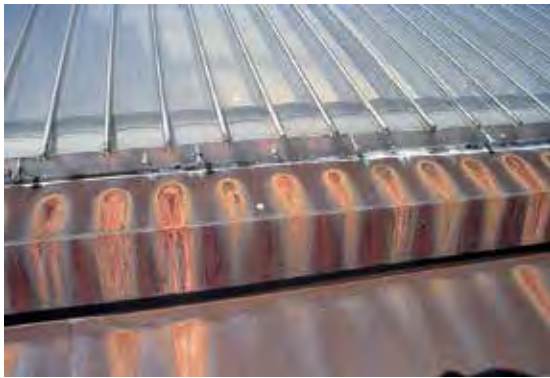

Acid rain which is concentrated and runs down from a plastic roof does not allow a protective oxide layer to form on the underlying copper sheet.

Much attention has been paid over the last few years to the phenomenon of holes forming in copper channels on account of fretting. There are likely to be two reasons for this problem: the fact that building methods have changed, and the fact that rainwater is now more acidic. If water runs down in great concentrated quantities from inert surfaces, such as felt, brick or slate, onto copper sheeting, the runoff path should initially be concentrated to or a simple wear plate – which can easily be replaced – should be fitted over the point at which the water hits the copper sheeting.

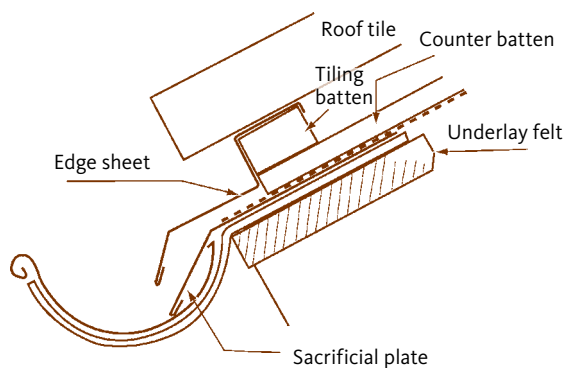

Sacrificial plate at the eaves, together with a copper gutter on a roof covered with roof tiles.

### Pipe flashings

All holes in a roof covering have to be made in such a way as to ensure that the roof remains watertight. Leaks can also occur due to mechanical damage, falling snow and corrosion. The connections must be checked carefully on pipe flashings and other types of opening.

### Cowling

Most buildings are fitted with some type of ventilator cowling or ventilating chimney. The tightness and fixing of these must be checked, and it is necessary to look for corrosion damage and mechanical damage. The fitting of ventilator grilles must be checked, as must their ability to withstand penetrating snow and rain.

There is a great risk of corrosion damage occurring behind baffles, particularly if the chimney gutter (slope) is missing, rubbish is not cleared away and the area not cleaned regularly.



Encasements, side flashings and top flashings must be checked for corrosion damage and tightness, their fitting must also be checked. Are these protected from insects? Is there a chimney gutter which can drain off water?

### Roof lights

Roof lights are checked in the same way as roof hatches. It is also necessary here to check the glazing: the putty and the tightness of the window frame seal, and to check that the glass is not broken.

### Monitor roofs, combustion gas ventilators

In the case of monitor roofs, the tightness of the monitor roof and the connections between the roof covering and the structure must be checked. Is there any leakage, corrosion damage, mechanical damage, broken glass, etc. Any movement joints fitted must also be examined.

### Roof hatches

The connections between the roofing material and the hatch must be checked. Check the flashing in particular. Is there any chimney gutter?

### Dormer windows

Dormer windows and roof structures for fan rooms can often resemble small buildings built on top of another, larger, building. Here, one will often find the same types of detail as are found on roofs, although on a smaller scale. This means that the covering and connections must be checked in the same way as on roofs.



Remember that the ridge and gable walls are the parts of a roof most exposed to the wind stresses.



The flashing on details which are exposed to the wind must be checked, especially their fittings.

### Chimneys

Chimneys flashings are considered to be vulnerable. In a short time, airborne pollutants can give rise to corrosion damage. Lead flats are often used as top flashings in the case of boiler chimneys. Stainless sheeting is now recommended for use. The joints may have been subject to corrosion and has broken, and so these must be examined carefully. Encasements and side flashings must be checked for corrosion damage, tightness and mechanical damage.

### Cover flashings

Cover flashings are fitted at joints between roofs and higher walls or similar. These flashings may be of various designs, depending on the roofing material and structure. In some cases, the cover flashings are designed in such a way as to permit ventilation of the roof structure. The cover flashings must be checked for corrosion damage, damage caused by expansion (due to movements) and mechanical damage. The joints between different materials must be checked with a view to the risk of leakage. Fittings must be checked.

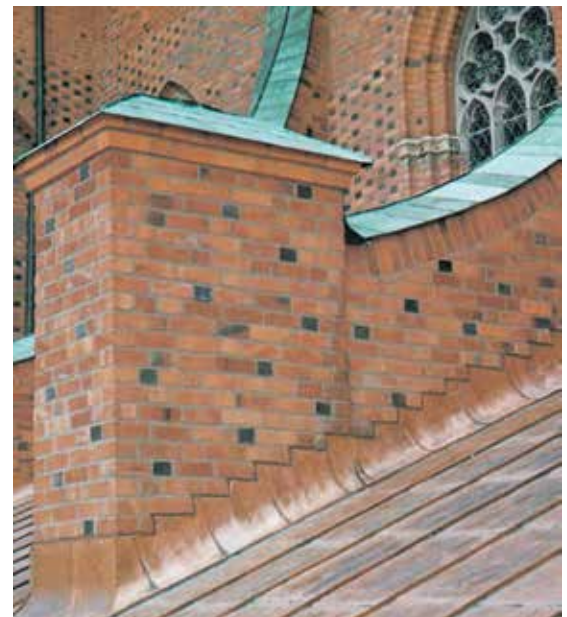

In the case of cover flashings, check their fittings and tightness, and look for corrosion damage, damage caused by expansion and mechanical damage.

### Suspension plates, barge board flashings

The roof covering ends at the roof projection, e.g. with a ridge or just a suspension plate or barge board flashing. Suspension plates etc. are checked for corrosion damage and, where necessary, tightness and their fittings are also checked.

### Ridges, ridge flashings

There are a number of different types of ridge which can be used depending on the design of the roof. One feature that these all have in common is the fact that they must be designed with a sufficient slope so that no water is permitted to remain on the ridge. If there is no slope, there is a great risk of water penetrating into the cross-joints on the ridge flashing. The fittings of the ridge flashings must be checked, particularly at points where they are exposed to the wind. Where plaster, brick and other moisture-absorbing facade materials have been used, it is important to check that the suspension plate is sealed and has sufficient overhang to protect the facade.

Facades made of non-water-repellent materials such as plaster, sandstone, brick, wood, etc. must be protected against the direct action of rain, snow, sleet or hail. Water running or dripping onto these will result primarily in ugly marks made by the water, but there is also a risk of frost causing the plaster to crack or wooden

details to rot. When matched correctly, maintenance-free copper sheeting offers ideal protection here as a wall cladding or window edge flashing, for covering mouldings, as a base flashing, etc.

Acid rain becomes slightly cupreous when it runs across a copper surface. If, for example, a pale stone section comes into contact with this kind of water, it will be discoloured, taking on a bluish-green hue. Another consequence of water which contains copper is that when it comes into contact with less noble metals such as aluminium, iron and zinc, it can cause galvanic corrosion.

It is therefore extremely important to check carefully that the water running off copper surfaces is drained correctly. All flashings on plastered walls should therefore be terminated with drip mouldings which run no less than 60 mm beyond the finished wall.

In addition to the details we have mentioned, roofs are often fitted with a range of other equipment which also has to be taken into account when carrying out a thorough maintenance inspection. TV aerials, advertising signs, lightning conductors etc. are often put up on roofs as the need arises, and they must be fitted in such a way as to not damage the roof covering and roof functions. Check the tightness of the roof at the connection points and the strength of the fittings.



Water which contains copper can discolour pale surfaces and cause corrosion.



A wide facade moulding fitted with a gutter to allow water to run off. Mouldings of this kind are made in the same way as roof coverings.



A beautiful roof is worth maintaining.



Correctly manufactured details and good maintenance are important criteria necessary to ensure that a roof does its job.



Lund Cathedral,  
Visitors' Centre, Sweden

# Costs



# Cost estimates, costings...

When constructing new buildings or renovating old, the developer, property manager, etc. is faced with a series of financial choices and decisions to make. The consequences of these choices and decisions, be they good or bad, often do not make themselves felt until the actual administration process is well under way.

Very thorough assessments are made of the administration period's overall income, costs and expenditure. Strict budgets are drawn up for each individual project, and long-term costings are prepared.

Good materials and careful materials handling mean good, long-lasting results – this is a dependable philosophy for investment in the construction industry these days. The choice of construction materials and selection of the level of quality to be applied are all decisions which will make themselves felt sooner or later in the form of the colour of the figures in the economic report – be they red or black.



Copper has a long service life.

When it comes to selecting materials for the external surface of the building, it is necessary to draw up a cost estimate for the entire administration period or loan period in which it is possible to see the effects of the various materials on the overall economy of the building. It is important to take into account as many factors as possible which would be of significance to the overall performance of the building: the service lives of the materials used, maintenance requirements, aesthetic durability, attractiveness, etc.

One parameter of major significance to the economic viability of a building is what is known as the “working life” of various materials. The working life of the building should be established so as a correct assessment covering the long term cut consequences can be made. Are we talking ten years, fifty years, a hundred years, or more?

In the same way, the durability of various materials should be assessed. The costs and intervals for necessary maintenance, repair and for replacing materials during the working life of the building, also have to be taken into account. Precise information on the service life and maintenance requirements of a material, converted into cost, can be difficult to find, but information is available on classic materials which are often used.

Service life aspects, e.g. the need for repair and maintenance, are also linked with the quality of the work done on constructing the building. If a first-class metal is used, highly-skilled sheet-metal workers should also be used.

When it comes to using a material such as copper, which is very durable and has a long service life, it may be the case that the service life of the material will exceed the potential working life of the building. In cases like this, the residual value of the material at the end of the working life of the building should also be taken into account in the costings.

The cost of capital also has to be taken into account in order to be able to compare in a relevant way the costs which arise at various times. The level of this cost is of significance to the end-result of the cost estimate.

## ASSESSMENT:

The example shows that at the materials purchasing stage, it is necessary to draw up a cost estimate based on the entire administration period in order to generate reliable cost data. Low purchase prices, as in this case, may mean operating costs that are higher than planned in the slightly longer term.

Furthermore, in our example, after 60 years of use the copper sheeting represents a not insignificant metal value when it is sold and sent for recycling.

According to an industry-wide survey carried out by Davies Langdon Consultancy in the United Kingdom, it is clear that copper and stainless steel are by far the two most cost-effective roof covering materials in all categories over working lives of 60 years and above.

Drawings of one and the same type building were sent to roof covering companies all over the United Kingdom. These companies were then asked to assess and price, as far as was possible for them, a complete roof covering using a number of different materials. They were also asked to specify how often the various roof covering materials needed to be maintained and repaired or replaced, as well as how much this work would cost. The companies were then also asked to work on the basis of their specific experience of various materials to estimate how long these would all last. The results of this survey were favourable as far as copper sheeting and stainless steel sheeting were concerned.

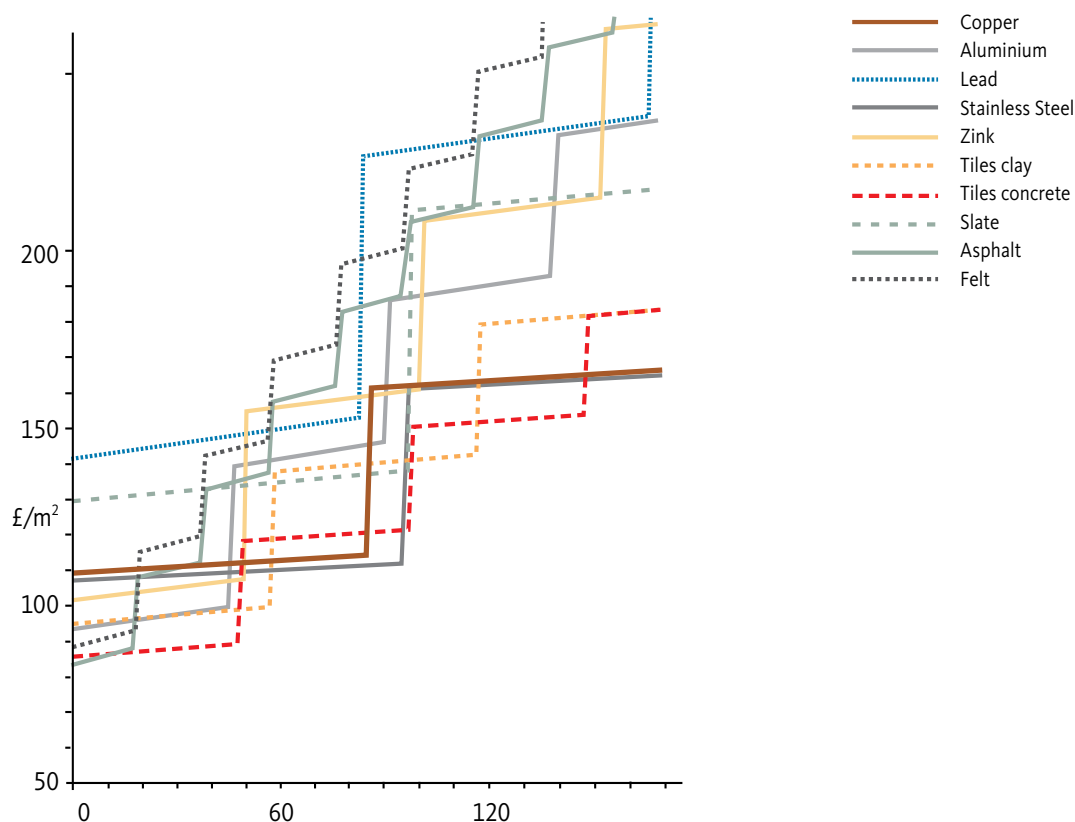

The results from this survey, compiled and presented in the form of a graphical illustration by Davies Langdon Consultancy, are shown below.



Aerial photo of the Aurubis headquarter in Hamburg, Germany.

# Aurubis

Our copper for your Life



## **AURUBIS – THE RED GOLD**

Aurubis means “red gold”, coming from the latin words “aurum rubrum”. The company is the leading integrated copper group and the world’s largest copper recycler. We produce some one million tonnes of copper cathodes each year and from them a variety of copper products.

Aurubis has about 6,400 employees, production sites in Europe and the USA and an extensive service and sales system for copper products in Europe, Asia and North America. Thanks to our wide range of services, we rank among the global leaders in our industry. Our core business is the production of marketable copper cathodes from copper concentrates, copper scrap and recycling raw materials.

These are processed within the Group into continuous castwire rod, shapes, rolled products and strips as well as specialty wire made of copper and copper alloys. Precious metals and a number of other products, such as sulfuric acid and iron silicate, round off our product portfolio.

Customers of Aurubis include companies in the copper semis industry, the electrical engineering, electronics and chemical industries as well as suppliers of the renewable energies, construction and automotive sectors.

Aurubis is oriented to growth and to increasing corporate value. The main focus of our strategy is on strengthening our business, utilizing growth opportunities and practicing a responsible attitude when dealing with people and handling resources and the environment.

Aurubis shares are part of the Prime Standard Segment of the Deutsche Börse and are listed in the MDAX, the European Stoxx 600 and the Global Challenges Index (GCX).

## **AT HOME IN THE WORLD OF COPPER**

Aurubis cooperates with schools and universities at various sites. Pupils gain in-sights into Aurubis’ occupational fields and scholarships for foreign language study trips abroad and receive information about climate protection, conservation and a healthy diet.

The Hamburg project 9 Plus even enables school leavers without an apprenticeship to take part in an internship with the prospect of an apprenticeship.

Students are supported with scholarships and can participate in internships or write papers and thesis projects with us.

Young people are not only fostered in education. Aurubis is also involved in sports. Whether biking, ball sports or water sports – promoting team sports that encourage fairness and strengthen team spirit is important to us. The volleyball players of the German National League team VT Aurubis receive special support – a commitment that benefits both professional sports and young sports talents.

Our involvement in social projects cannot be overlooked. Aurubis is strongly committed to such initiatives, such as providing new beds for a kindergarten or activities for socially disadvantaged children during the school holidays.

We also facilitate cultural and neighborhood projects which are always related to the topic of copper or which affect the direct surroundings of our plants. At the Bulgarian site, local residents can obtain information about Aurubis and discuss their concerns at centrally located information offices.

Take a look at the copper architecture around you as well: whether in the restoration of monuments or new roofs, Aurubis is present.

The history of our company is characterized by dynamics and flexibility – a company that was already founded as a stock corporation in 1866. In the meantime, the Aurubis Group is ideally positioned: With about 6,400 employees at production sites in Europe, the USA and China as well as sales offices worldwide, we are one of the leading integrated copper groups. Worldwide, we occupy a leading position in copper recycling. Aurubis stands for innovative prowess, the leading edge in technology, exemplary environmental protection, customer value and profitability.

The combination of copper production and processing into copper products and tailored special solutions makes us unique: two production areas, perfectly attuned to each other.



Our subsidiaries and holdings supplement these activities in an ideal manner. With this positioning we are staking out central market areas along the copper value chain and guarantee our customers top service and maximum benefit.

## **COPPER – THE RED GOLD**

High productivity and processing depth, consistent market orientation and close customer relations are the foundation of our success.

The processing of raw materials and the generation of products involves the utilization of technologically efficient and environmentally friendly processes and techniques.

From copper of the highest purity, we produce continuous cast wire rod and shapes, pre-rolled strip, strips, specialty wire, profiles and copper alloys – essential starting material for our customers.

In addition, we market all of the natural accompanying elements from copper products. This includes precious metals, sulfuric acid and iron silicate.



Our customer structure reflects the diversity of our product range: companies active in the electrical engineering, telecommunications and chemical industries, as well the construction industry, the automotive industry and mechanical engineering sector use our materials. We utilize the many different properties of copper in a targeted manner. The development of innovative products and integrated recycling solutions connected with operational efficiency secure our leading position – now and in future. We are far more than simply a copper producer – we are a gateway to the world of copper.

### **THE MATERIAL OF PROGRESS**

Copper is the oldest metal used by the human race. Some 10,000 years ago the “red gold“ was already used to make tools, utensils and dishes. There is hardly another material that is as versatile and offers such a wide range of potential applications. Thanks to its many exceptional properties, copper is an essential basic metal that is an indispensable part of modern life.

Copper is the material of the future par excellence. Whether telecommunications, energy supply or transportation and traffic infrastructures: The demand for copper not only increases with progress, but makes it possible in the first place. Copper paves the way for innovative developments, creates dynamics and plays a key role in the development of new technologies.

From live transmissions over the Internet to e-mails spanning the globe and all the way through to our power supply – copper is essential in achieving a high standard.

Thanks to its excellent conductivity, copper ensures the reliable transfer of information and energy. In house construction too, copper is un-beatable: not only for sanitary applications and electrical wiring, but also for roofs and facades that brave the elements and impress with their attractive architectural design and flair. Increasing comfort and high-tech: copper is an essential part of the picture.

### **SUCCESS IS A MATTER OF APTITUDE...**

We are focused on sustainable growth and long-term value enhancement. That is one of the reasons why Aurubis ranks among the international leaders in the copper industry.

The foundation of the success of all of our corporate sectors lies in employee competence and motivation. It is their skills and creativity that unlock the door to innovative prowess at Aurubis. And with the power of innovation, we are ideally placed for the future.

At Aurubis, our international outlook has earned us great expertise. Ultra-modern plants, top product quality, maximum efforts to protect the environment, excellent health and safety levels: however, none of this would be possible without a motivated and committed workforce.

Consequently, we go the extra mile to ensure that we are an attractive employer for our personnel. The low fluctuation rate is proof of the job satisfaction our employees experience – with the average period of service amounting to 16 years. It is also a clear indicator that our employees appreciate and make good use of the prospects and opportunities open to them within



the Group. It is not unusual for members of our staff to celebrate their 40-year tenure at Aurubis.

Our personnel comprise a variety of cultures and individual personalities. This is respected. We evaluate our employees based on performance regardless of function and position, not according to personal qualities or cultural background.

Five values were developed with employees from all the production sites to strengthen our corporate culture: performance, responsibility, integrity, mutability and appreciation. These company values and a group-wide Code of Conduct serve as the basis for sensitive and respectful interaction.

Team spirit always takes priority, as significant objectives can only be met together with a determined effort.

## **FAR-REACHING RESPONSIBILITY**

Aurubis cares not only about the well-being of our employees, but also that of society at large. We are an attractive employer for our personnel, and we would like to be a good neighbor to local residents at all sites. For Aurubis, entrepreneurial responsibility means helping to shape the community actively and sustainably.

Education, sports and culture – Aurubis supports social and cultural projects as well as the preservation of significant monuments and buildings at its sites.

The future of young people is especially important to us. We are active in promoting education and are involved with special training and qualification measures.



**Chicago** (USA)



**Buffalo** (USA)



**Avellino** (Italy)



**Mortara** (Italy)



**Yverdon-les-Bains** (Switzerland)



**Lyon** (France)



**Madrid** (Spain)



**Emmerich** (Germany)



**Fehrbellin** (Germany)



**Hamburg** (Germany)

Group headquarters



**Lünen** (Germany)



**Röthenbach** (Germany)



**Stolberg** (Germany)



**Strass**



## Facts & Figures Aurubis

**6,400** » employees work at Aurubis AG today in over 20 countries on three continents.  
The company was founded in 1866 as Norddeutsche Affinerie Aktiengesellschaft.

**1.1** » million tonnes of copper products are produced annually.

**>370** » million euro have been invested in environmental protection measures since 2000 alone.

**99.99 %** » copper content in our copper cathodes at the least – this high purity ensures that our products are of excellent quality.

**>200.000** » tonnes of strip have been produced in the fiscal year 2011/12.

### Raw materials

Concentrates and recycling materials are the raw materials from which copper is produced.



Concentrates Recycling material

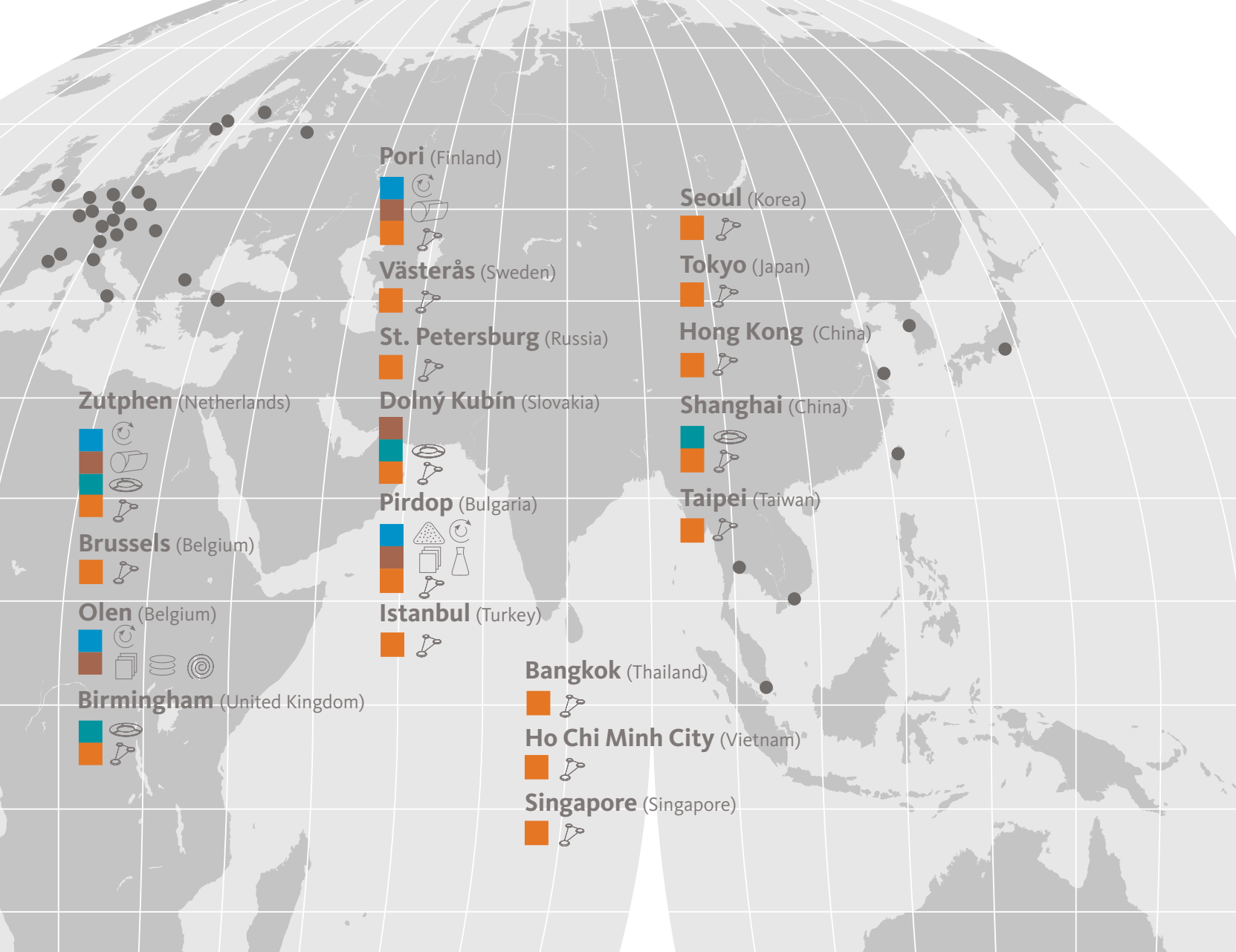

**Zutphen** (Netherlands)



**Brussels** (Belgium)



**Olen** (Belgium)



**Birmingham** (United Kingdom)



**Pori** (Finland)



**Västerås** (Sweden)



**St. Petersburg** (Russia)



**Dolný Kubín** (Slovakia)



**Pirdop** (Bulgaria)



**Istanbul** (Turkey)



**Seoul** (Korea)



**Tokyo** (Japan)



**Hong Kong** (China)



**Shanghai** (China)



**Taipei** (Taiwan)



**Bangkok** (Thailand)



**Ho Chi Minh City** (Vietnam)



**Singapore** (Singapore)



## Products

The copper is processed into products. Some products are already the result of copper production.

- Cathodes
- Continuous cast shapes
- Wire rod
- Strips/foils
- Specialty rod/profiles, shaped wire
- Precious metals
- Foxrod
- Other metals
- Sulphuric acid
- Iron silicate

## Service Centres

Service Centres located near our customers cut strips to the desired dimensions.



## Sales and distribution

An international sales and distribution network markets our products.



## Trade

Trading sites serve to supply our plants with recycling raw materials.



## **Imprint**

### **Editor**

Lennart Engström  
Aurubis AG

### **Layout and technical production**

Naula Grafisk Design  
Sweden

### **Printing**

Strålings Grafiska AB 2013  
Sweden

© 2013 Aurubis  
Second edition 2013  
First edition 2002

Our Copper for your Life

[www.aurubis.com](http://www.aurubis.com)

